



remedē[®] System

System Implant and Clinician Use Manual

remedē[®] Implantable Pulse Generator Model 1600, 1100, 1001

remedē[®] System Programmer Model 1002A

remedē[®] System Programming Wand Models 1004A, 1004A–F

remedē[®] External IPG Model 1006, 1006A

remedē[®] Lead Test Adapter Model 1007

respistim[®] L Stimulation Lead Models 2001, 2002, 2003, 2004

respistim[®] LQ Stimulation Lead Models:

IS-1 Terminal Models: 5045 - 5085, 5145 - 5185

In line Terminal Models: 5645 - 5685

respistim[®] LQS Stimulation Lead Models:

IS-1 Terminal Models: 4045 - 4085, 4145 - 4185

In line Terminal Models: 4645 - 4685

respistim[®] R Stimulation Lead Models:

IS-1 Terminal Models: 3101 - 3106, 3201 - 3206

In line Terminal Models: 3601 - 3606, 3611 – 3616, 3651 – 3656

RxOnly

TABLE OF CONTENTS

TABLE OF CONTENTS	1
LIST OF TABLES	3
LIST OF FIGURES	4
1.1 Symbols Used on Product or Package Labeling	5
1.2 Introduction	7
1.3 Indications for Use	7
1.4 System Overview	7
1.5 Description of System Components	7
1.5.1 remedē ® IPG	7
1.5.2 respistim ® Stimulation Leads	8
1.5.3 Respiratory Sensing Lead	9
1.5.4 Lead Test Adapter	9
1.5.5 remedē ® System Programmer	10
1.5.6 remedē ® Programming Wand	10
1.5.7 remedē ® External IPG	11
1.6 Contraindications	12
1.7 Warnings and Precautions	12
1.7.1 Warnings	12
1.7.2 General Precautions	15
1.7.3 Home or Work Environment Precautions	15
1.7.4 remedē ® System Therapy Hazards	16
1.8 Adverse Effects	17
1.9 Clinical Data Summary	18
1.9.1 Pivotal Trial of the remedē ® System	18
1.9.2 Patients Studied	18
1.9.3 Study Design and Methods	19
1.9.4 Study Results	20
1.10 Storage and Handling	26
1.10.1 Stimulation Leads	26
1.11 Clinician Training	27
1.12 remedē ® System Implant	27
1.12.1 Mitigation Strategies for Managing the Risk of Infection During remedē ® System Implant, Replacement and Explant Procedures	27
1.12.2 Implantable System	27

1.12.3	remedē [®] System Implant Procedure.....	27
1.12.4	Concomitant Cardiac Device Testing (if applicable).....	38
1.12.5	Postoperative Care.....	38
1.12.6	Physician Instructions to Patient.....	39
1.12.7	Patient Registration.....	39
1.12.8	Surgical Revision and Explant.....	39
1.13	Using the remedē [®] System Programmer.....	40
1.13.1	remedē [®] System Programmer.....	40
1.13.2	Preparing for a Clinical Programming Session.....	42
1.14	remedē [®] System Limited Warranty.....	50
1.15	Appendix I: remedē [®] System IPG Specifications.....	53
1.15.1	Physical Characteristics.....	53
1.15.2	Lead Connectors.....	53
1.15.3	Radiopaque Identification.....	53
1.15.4	Battery Information.....	54
1.15.5	Programmable Settings.....	55
1.16	Appendix II: respistim [®] L, LQ, and LQS Stimulation Lead Specifications.....	57
1.16.1	Physical Characteristics.....	57
1.17	Appendix III: respistim [®] R Lead Specifications.....	59
1.17.1	Physical Characteristics.....	59
1.18	Appendix IV: Additional Programmer and eIPG Details.....	61
1.18.1	Power Supply.....	61
1.18.2	Routine Cleaning.....	61
1.18.3	Cybersecurity Considerations.....	61
1.18.4	eIPG Cable.....	61
1.19	Appendix V: remedē [®] System Programmer Electromagnetic Interference Information.....	62
1.20	Appendix VI: remedē [®] System Programmer Communications & Telemetry.....	67
1.20.1	Telemetry Data.....	67
1.20.2	Troubleshooting.....	67
1.21	Appendix VII: Service and Disposal Information.....	69
1.21.1	Service.....	69
1.21.2	Disposal.....	69

LIST OF TABLES













Table 1	Baseline Demographics	19
Table 2	Summary of Freedom from Related SAEs through 12 Month Visit (ITT)	20
Table 3	Summary of Serious Adverse Events by Relation to Implant Procedure, remedē [®] System, or Delivered Therapy through 12 Months	21
Table 4	Summary of Related non-Serious Adverse Events and Observations through 12 Months	22
Table 5	Summary of System Explants	24
Table 6	Summary of Reasons for Trial Withdrawals	24
Table 7	Summary of the Comparison of the Proportion of Patients with $\geq 50\%$ Reduction in AHI at 6 Months (Modified ITT)	25
Table 8	Environmental Temperature Limits	26
Table 9	Recommended Stimulation Threshold and Impedance Values	32
Table 10	remedē [®] System Software Application Toolbar Icons	45
Table 11	Battery Status Indicator Level	47
Table 12	remedē System IPG Physical Description.....	53
Table 13	remedē System IPG Battery Information	54
Table 14	remedē System IPG – Battery Longevity Estimates.....	54
Table 15	remedē [®] System IPG Programmable Settings.....	55
Table 16	respistim L, LQ, and LQS Lead Model Descriptions (IS-1 Terminal Models)	57
Table 17	respistim LQ and LQS Lead Model Descriptions (In-line Terminal Models)	58
Table 18	respistim R Model Descriptions (IS-1 Terminal Models)	59
Table 19	respistim R Model Descriptions (In-line Terminal Models)	60
Table 20	Electromagnetic Emissions Guidance Declaration	62
Table 21	Electromagnetic Immunity Guidance Declaration	63
Table 22	Electromagnetic Immunity Guidance Declaration	64
Table 23	Recommended Separation Distances Between Portable and Mobile RF Communications Equipment	65
Table 24	Frequencies of Portable and Mobile Transmitters for which the Recommended Separation Distance is 30 cm (12 inches).....	66
Table 25	Telemetry Transmission Characteristics	67













LIST OF FIGURES

Figure 1	Model 1001 remedē ® System IPG with 4 IS-1 Ports	8
Figure 2	Model 1100 remedē ® System IPG with 4 IS-1 Ports	8
Figure 3	Model 1600 IPG with one In-line Port.....	8
Figure 4	Model 1007 – Lead Test Adapter	10
Figure 5	The remedē System Programmer.....	10
Figure 6	The remedē Programming Wand (Model 1004A).....	11
Figure 7	Model 1006A EIPG and Model 1006 EIPG	11
Figure 8	Typical Left Pericardiophrenic Vein Anatomy	28
Figure 9	Lead Adapter in the Open Position	30
Figure 10	Visualizing terminal pin electrodes 1 and 6 through windows	30
Figure 11	Recommended IPG Pocket Location	33
Figure 12	The remedē ® IPG Connector Block and Port Diagram.....	34
Figure 13	respistim ® L Stimulation Lead Connections	34
Figure 14	respistim ® LQ and LQS Stimulation Lead Connections	34
Figure 15	respistim ® R Stimulation Lead Connections	35
Figure 16	IS-1 IPG/Terminal Pin Connections-Acceptable and Unacceptable pin depth	35
Figure 17	The remedē ® IPG Connector Block and Port Diagram.....	36
Figure 18	The respistim In-line Terminal Pin	36
Figure 19	Tighten setscrew using the green In-line Torque Wrench.....	37
Figure 20	Proper Rotation of IPG to Wrap Excess Lead Length	38
Figure 21	remedē System Programmer Tablet Display (Model 1002A)	40
Figure 22	remedē System Programmer Tablet.....	41
Figure 23	The remedē System Programmer Wand	41
Figure 24	Programmer SW 4.5.0.6 and Programmer SW 5.0.X.X Icons	43
Figure 25	SW 5.0.X.X Alert if Attempting to Communicate with Model 1001 IPG	43
Figure 26	SW 4.5.0.6 Alert if Attempting to Communicate with Model 1100/1600 IPG	43
Figure 27	remedē System Software Application Screen	44
Figure 28	Interrogate Button	47
Figure 29	remedē ® System Programmer Wand Urgent Off Button	48
Figure 30	Example of Programmer alert when device has entered in Safe mode	49
Figure 31	Summary tab display when Implantable Device is in Safe Mode.....	49
Figure 32	remedē System IPG Radiopaque Identifier.....	53

1.1 Symbols Used on Product or Package Labeling

Refer to individual product for applicable symbols.

	Applies to U.S. audiences only
	Catalog or Reference Number
	Lot Number
	Sterilized using ethylene-oxide gas
	Sterile Lot Number
	Do Not Reuse/Single Use Only
	Do Not Resterilize
	Temperature Limitation/Temperature Range
	Caution
	MR Unsafe
	MR Conditional
	Use by/Expiration date

	Date of Manufacture
	Manufacturer
	Quantity in Package
	Inside Diameter
	Outside Diameter
	Length
	Consult Instructions for Use
	Keep away from heat and keep dry
	Type B Applied Part – No electrical connection to patient and may be grounded
	Type BF Applied Part – Electrically connected to patient but not directly to the heart
	Type CF Applied Part – Electrically connected to the heart of the patient
	Non-ionizing electromagnetic radiation
	Federal Communications Commission notice (USA)

RxOnly	Use by prescription only
--------	--------------------------

1.2 Introduction

This manual is intended to provide clinicians with information regarding the implant and use of the **remedē**® System. Included in this manual are descriptions of the **remedē** System as well as instructions for handling, storing and surgical placement of the **remedē** System. This manual also includes an overview of the **remedē** System therapy and instruction for clinical use and follow-up care of patients using the **remedē** System Programmer.

1.3 Indications for Use

The **remedē**® System is an implantable phrenic nerve stimulator indicated for the treatment of moderate to severe central sleep apnea (CSA) in adult patients.

1.4 System Overview

The system consists of an implantable pulse generator (IPG), one transvenous lead to stimulate the phrenic nerve, and one optional transvenous sensing lead to sense respiration via transthoracic impedance (sensing lead compatible with Model 1001/1100 IPG only). External, non-implanted devices and accessories of the **remedē** System include the **remedē** System Programmer, external IPG, and programming wand.

1.5 Description of System Components

All implanted components of the **remedē** System are intended for single use only.

1.5.1 **remedē**® IPG

The **remedē** IPG is an implantable, multi-programmable stimulator designed for unilateral, transvenous phrenic nerve stimulation. The device monitors the patient's respiratory signals and provides electrical stimulation to the left or right phrenic nerve to restore patients to a normal breathing pattern during sleep. The **remedē** IPG contains electronic circuitry components and a battery, which are hermetically sealed in a titanium case. Therapy settings are determined by the physician and configured using an external programmer via telemetry.

The **remedē** IPG Model 1001 (**Figure 1**) and 1100 (**Figure 2**) have four 3.2 mm connector ports that are compatible with IS-1 terminal pins. The IS-1 lead terminal pin in each 3.2 mm connector port is secured by two set screws.

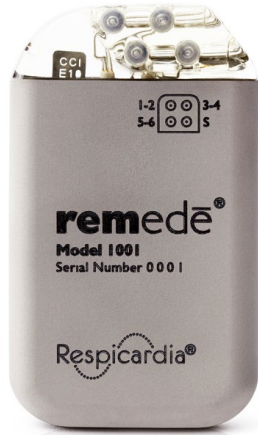

Figure 1 Model 1001 remedē® System IPG with 4 IS-1 Ports



Figure 2 Model 1100 remedē® System IPG with 4 IS-1 Ports

The remedē IPG (Model 1600, [Figure 3](#)) has a single In-line connector port that is compatible with the respistim LQ, LQS and R Stimulation leads with an In-line terminal pin/connector (LQ Models 56XX, LQS Models 46XX, and R Models 36XX). The In-line lead terminal pin is secured by one set screw. The model 1600 IPG uses the stimulation lead for sensing respiration and does not provide a connector port for a dedicated sensing lead.



Figure 3 Model 1600 IPG with one In-line Port

1.5.2 respistim® Stimulation Leads

The respistim L (left) family of leads and a respistim R (right) family of leads was developed for phrenic nerve stimulation to treat CSA. The respistim family of stimulation leads is comprised of unique transvenous leads designed for chronic stimulation and sensing when placed in a thoracic vein and connected with a compatible pulse generator.

1.5.2.1 respistim® L Stimulation Lead

The respistim L stimulation lead (Models 2001, 2002, 2003, and 2004) is a bipolar, transvenous, over-the-wire lead. The proximal end of the lead contains one IS-1 terminal pin/connector and the distal end is comprised of two ring electrodes. The lumen of the lead is continuous, permitting the passage of a 0.014” guide wire for delivery into the desired target vein.

1.5.2.2 respistim® LQ Stimulation Lead

The respistim LQ stimulation lead is a quadripolar, transvenous, over-the-wire lead. Models 50XX and 51XX (where XX denotes the lead length in cm) have two IS-1 terminal pins/connectors on the proximal end of the lead and is secured in the compatible IPG using 4 setscrews. Models 56XX (where XX denotes the lead length in cm) have one In-line terminal pin/connector that is secured in the compatible IPG using bal seal contacts and a single setscrew. All respistim LQ stimulation lead models have four ring electrodes on the distal end of the lead and the lumen of the lead is continuous, permitting the passage of a 0.014” guide wire for delivery into the desired target vein.

1.5.2.3 respistim® LQS Stimulation Lead

The respistim LQS stimulation lead is a quadripolar, transvenous, over-the-wire lead with a distal-end S-shaped bias for passive fixation within the vein. Models 40XX and 41XX ((where XX denotes the lead length in cm) have two IS-1 terminal pins/connectors on the proximal end of the lead and is secured in the compatible IPG using 4 setscrews. Models 46XX (where XX denotes the lead length in cm) have one In-line terminal pin/connector that is secured in the compatible IPG using bal seal contacts and a single setscrew. All respistim LQS stimulation lead models have four ring electrodes on the distal end of the lead and the lumen of the lead is continuous, permitting the passage of a 0.014” guide wire for delivery into the desired target vein.

1.5.2.4 respistim® R Stimulation Lead

The respistim R stimulation lead is a hexapolar, transvenous, stylet delivered lead. The distal end of the lead is comprised of a helical shape bias with six ring electrodes and a non-electrically active tip having a helical shape bias. The lead is designed for use with a stylet to remove the distal bias and permit delivery of the lead into the desired target vein. Models 3101 - 3106, 3201 - 3206 have three IS-1 terminal pins/connectors on the proximal end of the lead and is secured in the compatible IPG using 6 setscrews. Models 3601 – 3606, 3611 – 3616, and 3651 - 3656 have one In-line terminal pin/connector that is secured in the compatible IPG using bal seal contacts and a single setscrew. See respistim R lead specifications in Appendix III for the dimensions of each model number.

1.5.3 Respiratory Sensing Lead

The remedē System is designed to monitor respiration by sensing changes in transthoracic impedance. The system is capable of sensing respiration signals through either an implanted respistim stimulation lead or through an optional, commercially available IS-1 compatible bipolar lead (IPG Models 1001 and 1100 only).

1.5.4 Lead Test Adapter

The Model 1007 Lead Test Adapter ([Figure 4](#)) will interface with the In-line terminals of respistim leads. It permits acute electrical connection to In-line Stimulation Lead electrodes

during implantation. Electrical connection is made at the time of implantation to evaluate electrode placement within the vasculature.



Figure 4 Model 1007 – Lead Test Adapter

1.5.5 **remedē® System Programmer**

The **remedē** System Programmer (Model 1002A), **Figure 5** is a touch screen tablet computer used to communicate with the **remedē** implantable pulse generator (IPG) via inductive telemetry and allows for configuration of programmable settings, initiation of system testing and review of collected diagnostic data. Communication with the implanted device is achieved using the **remedē** programming software and an external programming wand (Model 1004A or 1004A-F) connected to the programmer via USB cable.



Figure 5 The remedē System Programmer

1.5.6 **remedē® Programming Wand**

The **remedē** System programming wands (Models 1004A, **Figure 6** and 1004A-F) connect to the System Programmer via USB and provide a magnetic inductive communication link to the implanted device. The Model 1004A programming wand requires placement of the wand directly over the implanted device for telemetry communication. The optional Model 1004A-F provides

an extended flexible antenna disc that must be placed directly over the implanted device and is intended to allow for real-time monitoring during a polysomnogram (PSG).



Figure 6 The remedē Programming Wand (Model 1004A)

1.5.7 remedē® External IPG

The remedē external IPG (Model 1006A or Model 1006, [Figure 7](#)) is used for evaluation of stimulation lead placement during implant of the remedē System. The external IPG (eIPG) delivers the same stimulation pulse as the remedē IPG and provides one set of anode and cathode connection ports for use with a sterile cable.

Model 1006A EIPG

Model 1006 EIPG



Figure 7 Model 1006A EIPG and Model 1006 EIPG

1.6 Contraindications

The **remedē** System is contraindicated for the following:

- Patients with an active infection

1.7 Warnings and Precautions

Carefully read all warnings, precautions, and instructions before use. Follow all operating, maintenance, and installation procedures as described in this manual. Failure to do so may result in patient harm.

1.7.1 Warnings

1.7.1.1 *Modified Components*

The use of modified components with the **remedē**[®] System is not allowed and may result in damaged components, unintended operation, or increased risks to the patient.

1.7.1.2 *Magnetic Resonance Imaging (MRI)*

The **remedē** System is MR Conditional which means that safety has been demonstrated only within specifically defined conditions. Scanning under different conditions may result in severe patient injury or device malfunction. Refer to the **remedē** System MRI guidelines manual for detailed information on MRI safety and conditions for MRI scanning of patients implanted with **remedē** System products.

1.7.1.3 *Concomitant Active Implantable Cardiac Devices*

It is recommended that testing for oversensing of **remedē** stimulation therapy by the concomitant cardiac device occur at the time of implant and prior to initiating **remedē** System therapy in patients with a concomitantly implanted cardiac device (testing protocol described on page 38). Programming of the **remedē** System and/or the concomitant device, when necessary, can prevent oversensing of **remedē** stimulation therapy.

To avoid telemetry interference, one telemetric programming system should be utilized at a time if the concomitantly implanted device uses magnetic inductive telemetry.

1.7.1.4 *Pacemaker Dependence*

Use **remedē** System therapy with caution in pacemaker dependent patients without a physiologic escape rhythm. It is recommended to test at the time of implant and prior to initiating **remedē** System therapy for oversensing of the **remedē** System and/or undersensing of the pacemaker which could result in a loss of appropriate pacing.

1.7.1.5 *Diathermy*

Do not use shortwave diathermy, microwave diathermy or therapeutic ultrasound diathermy (collectively referred to as diathermy) on patients implanted with the **remedē** System. Energy produced by diathermy equipment may be transferred through the implanted system and can

cause permanent tissue damage at the location of the implanted electrodes, resulting in severe injury or death.

Diathermy can also damage the **remedē** System, resulting in loss of therapy and requiring additional surgery for system explantation and replacement. Advise the patient to inform their health care professionals that diathermy exposure should be avoided.

1.7.1.6 Electric Shock

When operating under AC power, the **remedē** System Programmer must be connected to a grounded power source to avoid risk of electric shock.

1.7.1.7 Concomitant Active Implantable Devices

Use the **remedē** System with caution in patients with an active implantable device that may be susceptible to unintended interaction with the **remedē** system. Consult the **remedē** team to assess the possibility of interaction.

1.7.1.8 Patients with Evidence of Phrenic Nerve Palsy

Therapy with the **remedē** System may be ineffective in patients who have evidence of phrenic nerve palsy.

1.7.1.9 Pediatric Use

The safety and effectiveness of the **remedē**[®] System has not been established for pediatric use.

1.7.1.10 Electromagnetic Compatibility and Medical Procedure Precautions

The **remedē** System is intended to be used in either hospital or clinical establishments and is designed to ensure immunity from most common sources of electromagnetic disturbance. In most cases, turning off or moving away from the disturbance source will return the IPG to normal operation. Extremely strong sources of EM disturbance could interfere with normal IPG operation, causing the IPG to reset and requiring the programmed settings to be reconfigured. For information on MRI and diathermy, see ‘Warnings’ in sections 1.7.1.2 and 1.7.1.3.

1.7.1.10.1 Electrocautery

Electrocautery may induce failure of the IPG and leads if direct contact is made. Alternatives to electrocautery should be used when available. If electrocautery is necessary, the **remedē** System should be programmed off and bipolar cautery should be used. Confirm proper function of the **remedē** System after any procedure where electrocautery is used.

1.7.1.10.2 Radiofrequency or Cryoballoon Ablation

If radiofrequency or cryoballoon ablation must be used in the vicinity of the IPG or leads, the **remedē** System should be programmed off. Avoid direct contact between the radiofrequency ablation or cryoballoon catheter and the implanted **remedē** System.

1.7.1.10.3 Therapeutic Radiation

The IPG should not be directly irradiated by therapeutic levels of ionizing radiation (such as that produced by cobalt machines or linear accelerators used for treatment of certain cancers) because of the risk for damage to the **remedē** System. If such therapy is required, program the **remedē** System off, shield the device, and confirm proper function of the **remedē** System after treatment.

1.7.1.10.4 Computed Tomography (CT) Imaging

If a CT scan is required, ensure that the **remedē** System is off and confirm proper function of the **remedē** System after the scan is complete.

1.7.1.10.5 Therapeutic Ultrasound

Exposure to high ultrasonic frequencies may result in damage to the **remedē** System. It is not recommended to use high-output ultrasonic devices, such as an electrohydraulic lithotripter or bone growth simulator on patients implanted with the **remedē** System. If therapeutic ultrasound must be performed, program the **remedē** System off and keep the implanted system a minimum of 2.5 cm (1 in) away from the ultrasonic field. Confirm proper function of the **remedē**[®] System after treatment.

1.7.1.10.6 External Defibrillation Energy

The use of external defibrillation may cause damage to the **remedē** System. The risk of damage may be minimized by positioning the defibrillation patches or paddles a minimum of 15 cm (6 in) and perpendicular to the IPG. Confirm proper function of the **remedē** System after any use of external defibrillation.

1.7.1.10.7 Patient Monitoring Equipment

remedē System stimulation therapy may be detectable by patient monitoring equipment including automated external defibrillators. Confirm proper function of monitoring equipment if used while **remedē** stimulation therapy is active.

1.7.1.10.8 Transcutaneous Electrical Nerve Stimulators (TENS)

TENS therapy should be used only if the **remedē** System is inactive (not providing stimulation therapy). If TENS therapy must be used, place the TENS electrodes as far from the **remedē** System as possible. TENS electrodes should also be spaced as close together as possible to reduce the generated electrical field. Confirm proper function of the **remedē** System after use of TENS therapy.

1.7.1.10.9 Electrical Isolation During Implant

Do not allow the patient to have contact with grounded equipment that might produce electrical current leakage during implant. Electrical current leakage may induce arrhythmias that could result in patient death.

1.7.1.10.10 Lead Compatibility

Only use IS-1 lead or lead extension terminals with the Model 1001/1100 **remedē** System. Only use a **respistim** inline connector lead with the Model 1600 **remedē** System. Use of non IS-1 compatible terminals in the Model 1001/1100 or non-**respistim** In-line connector leads in the Model 1600 may result in undersensing of respiratory activity, failure to deliver necessary therapy, or a leaking or intermittent electrical connection.

1.7.1.11 Pregnancy

The safety and effectiveness of the **remedē** System during pregnancy has not been established.

1.7.1.12 Ventilatory Support

The safety and effectiveness of the **remedē** System in patients unable to support ventilation while awake has not been established.

1.7.2 General Precautions

1.7.2.1 Expiration Date

Do not use any **remedē** System product after its expiration date.

1.7.2.2 Storage Temperature Ranges

It is recommended the **remedē** System be stored in a dry place according to the temperature ranges below:

remedē® System	Temperature Ranges
remedē IPG	0°C (32°F) and 50°C (122°F)
respistim ® R, L, LQ, LQS Leads	5°C (41°F) and 30°C (86°F)
remedē System Programmer	-20°C (-4°F) and 70°C (158°F)
Programming Wand	-20°C (-4°F) and 70°C (158°F)
eIPG	0°C (32°F) and 50°C (122°F)

1.7.3 Home or Work Environment Precautions

1.7.3.1 High Powered Electric Fields

Normal operation of the **remedē** System can be affected by magnetic, electrical and electromagnetic signals with sufficient strength or with characteristics similar to respiratory activity. Consult with the **remedē** team if the patient will be in an area where contact with current carrying conductors is possible or near high powered electromagnetic fields caused by equipment such as arc welding units, induction furnaces, induction stoves, resistance welders, radio or microwave transmitters, and linear power amplifiers.

1.7.3.2 Cellular Phones

Normal operation of the **remedē** System may be affected by cellular phones. Maintain a minimum separation of 30 cm (12 in) between a cellular phone and the **remedē** System, even if the cellular phone is not on.

1.7.3.3 Electronic Article Surveillance (EAS)

Electronic article surveillance equipment such as retail theft prevention systems, as well as airport metal detectors, may interfere with the **remedē** System. Advise patients to walk directly through an EAS system and not remain near an EAS system longer than necessary. Where possible, alert security personnel of the implanted **remedē** System and request a manual search.

1.7.3.4 Common Radiofrequency Sources (e.g. RFID)

Normal operation of the **remedē** System may be affected by common radiofrequency sources. Patients should minimize time around radiofrequency sources, such as RFID, and when recognized they are nearby and operators of the **remedē** System external components should maintain a separation distance of 40cm from RFID systems.

1.7.3.5 Static Magnetic Fields

Patients should avoid equipment or situations where they would be exposed to static magnetic fields greater than 10 gauss or 1 mT. Static magnetic fields may suspend therapy until next scheduled therapy session. Sources of static magnetic fields include, but are not limited to, stereo speakers, bingo wands, extractor wands, magnetic badges, or magnetic therapy products.

1.7.3.6 Wi-Fi

Do not use or enable Wi-Fi on the **remedē** System Programmer to protect the system from cybersecurity risks.

1.7.3.7 Scuba Diving and Hyperbaric Chamber

Do not dive below 10 meters (33 feet) of water or enter hyperbaric chambers above 2.0 atmospheres absolute (ATA). Pressures below 10 meters (33 feet) of water (or above 2.0 ATA) can damage your stimulator or leads.

1.7.4 remedē® System Therapy Hazards

1.7.4.1 Risk of Arrhythmia

The stimulation lead should be placed in the right brachiocephalic vein or the left pericardiophrenic vein. Based on clinical study of leads placed in these locations, it is highly unlikely the heart would be electrically impacted by the levels of stimulation available in the **remedē** System (≤ 10 mA, 300 μ s). Based on clinical experience and animal testing experience with displaced leads, it is unlikely that a displaced lead would cause significant arrhythmias.

1.7.4.2 Muscle Stimulation in Unipolar Configuration

Under certain circumstances, such as high-output unipolar stimulation, therapy induced muscle stimulations may occur at the pocket site of the implanted device. This condition is mitigated by appropriate programming of the stimulation parameters by qualified medical personnel in conjunction with patient feedback.

1.7.4.3 Component Failure

As with any active implantable electronic system, the **remedē**[®] System might unexpectedly fail or stop working at any time due to random component fault, battery failure, exposure to extreme environmental disturbances or environmental conditions. These factors may reduce system longevity, effectiveness and cause change in the performance characteristics.

1.8 Adverse Effects

Possible adverse effects include, but are not limited to, the following:

Implant Procedure-Related

- Adverse contrast dye reaction such as allergic reaction, pulmonary edema, or worsening renal function
- Adverse reaction to radiation exposure
- Thromboembolism
- Air embolism
- Bleeding
- Cardiac perforation including tamponade
- Hematoma, seroma, local bruising or swelling
- Hypotension
- Local wound healing issues at device implant site including wound dehiscence, pocket erosion, extrusion, movement of implanted device, keloid formation
- Pneumothorax
- Hemothorax
- Vascular damage, e.g., venous dissection, perforation

Lead and System-Related

- Adverse biocompatibility reaction to the implanted system
- Infection
- Lead breakage
- Lead dislodgement
- Lead not connected or secured appropriately in device header
- Implantable device malfunction
- Requirement for more energy to stimulate the nerve or ineffective stimulation
- Venous occlusion

Therapy-Related

- Crosstalk with another implanted device
- Disrupted sleep
- Muscle fatigue or discomfort in diaphragm, chest or abdomen from appropriate stimulation
- Nerve dysfunction
- Perturbation of blood gases causing hypoxia, hypercapnea and/or hypocapnea
- Inappropriate sensations
- Worsening heart failure, respiratory status or overall health

Other Procedure, System or Therapy-Related

- Anxiety
- Arrhythmia, including ventricular fibrillation
- Death
- Depression
- Hypotension
- Pain
- Skin irritation or local allergic reaction
- Thrombus or embolism, potentially leading to pulmonary embolism or stroke
- Belching, burping

1.9 Clinical Data Summary

1.9.1 Pivotal Trial of the *remedē*[®] System

The *remedē* System was evaluated in a prospective, multicenter, randomized trial at study centers in the United States, Germany, and Poland for the indication of transvenous stimulation of the phrenic nerve for the treatment of central sleep apnea (CSA).

1.9.2 Patients Studied

The study enrolled 151 central sleep apnea patients who underwent an implant procedure. Of the 151 implant attempts, 147 (97%) were successful. The study endpoints were evaluated based on intent to treat. The patient demographics for the *remedē* System Pivotal Trial are included in [Table 1](#).

Table 1 Baseline Demographics

Baseline Measure	Mean N=151
Age (years)	65
Body Mass Index, kg/m ²	31
Ejection Fraction, %	40
AHI, events/hour	46
CAI, events/hour	28
	n (%)
Male	135 (89%)
Race	
Black or African American	6 (4%)
Unknown	1 (1%)
White	144 (95%)

1.9.3 Study Design and Methods

The **remedē**[®] System Pivotal Trial was a multicenter, prospective randomized trial conducted at 31 centers: 24 United States, 6 Germany, and 1 Poland. Prior to baseline assessments, patients were medically stable for 30 days in addition to having guideline recommended therapy appropriate for their clinical condition. Potential patients were identified by chart reviews and direct physician referrals. Pre-screening was performed via in-home sleep testing (polygraphy [PG]) or review of PSGs completed for clinical reasons.

Following pre-screening, potentially eligible patients prospectively underwent a qualifying overnight, attended PSG within 40 days prior to implant. Eligibility required the following PSG results: apnea-hypopnea index (AHI) ≥ 20 events/hour of sleep, central apneas (CAI) $\geq 50\%$ of all apneas and at least 30 central apnea events throughout the night, and an obstructive apnea index (OAI) $\leq 20\%$ of the total AHI. Key exclusion criteria included factors prohibitive of system implantation, phrenic nerve palsy, Stage D heart failure, a cerebrovascular event within 12 months, CSA secondary to opioids, and advanced renal disease.

All patients undergoing an implant attempt were randomized 1:1 to phrenic nerve stimulation (treatment) or control. The investigational system was implanted in both the treatment and control groups. All patients had a 1-month study visit after implantation that determined the schedule for subsequent follow-up at 3 month intervals. The system was activated in the treatment group at the 1-month visit according to a proprietary algorithm that applied a stimulation pattern which enabled full diaphragmatic contraction while the patient continued to sleep. A full night PSG was completed 6 months following the 1 month visit in all subjects to assess the primary effectiveness endpoint. The system remained off in the control group through the 6-month effectiveness assessment, after which therapy was initiated and remained on.

The primary effectiveness endpoint was a comparison of the proportions of patients in the treatment versus control groups achieving a reduction in AHI of $\geq 50\%$ from baseline to 6 months. The primary safety endpoint was freedom from serious adverse events associated with the implantation procedure, the system, or delivered therapy in the combined study groups through 12 months. A serious adverse event was defined as any adverse event that led to death, led to a serious deterioration in the health of the subject, resulted in a life-threatening illness or injury, resulted in a permanent impairment of a body structure or a body function, required inpatient hospitalization or prolongation of existing hospitalization, resulted in medical or surgical intervention to prevent permanent impairment to a body structure or a body function, or led to fetal distress, fetal death or a congenital abnormality or birth defect.

1.9.4 Study Results

1.9.4.1 Safety

1.9.4.1.1 Primary Safety Endpoint

The percentage of subjects free from serious adverse events (SAE) associated with the implant procedure, the **remedē**[®] system, or the delivered therapy through the 12 month visit was 91% [95% exact CI (86%, 95%)]. No statistical hypothesis testing was performed on this endpoint (**Table 2**).

Table 2 Summary of Freedom from Related SAEs through 12 Month Visit (ITT)

Variable	Pooled ¹ (N=151)
Freedom from related SAEs	91% (138) (86%, 95%)
¹ Percent (n) and 95% exact confidence interval.	

Thirteen subjects (9%) each reported a single implant procedure, **remedē** System, or delivered therapy related SAE. **Table 3** displays the number of each type of event reported, along with the number and percentage of subjects who experienced the event.

Table 3 Summary of Serious Adverse Events by Relation to Implant Procedure, remedē® System, or Delivered Therapy through 12 Months

Event	Pooled (N=151)							
	Implant, System and/or Therapy Related ^{1,2}		Implant Procedure Related		System Related		Delivered Therapy Related	
	n Events	% (n) Subjects	n Events	% (n) Subjects	n Events	% (n) Subjects	n Events	% (n) Subjects
ANY EVENT	13	9% (13)	9	6% (9)	6	4% (6)	2	1% (2)
IMPENDING POCKET EROSION	2	1% (2)	1	1% (1)	1	1% (1)	0	0% (0)
IMPLANT SITE INFECTION	2	1% (2)	2	1% (2)	0	0% (0)	0	0% (0)
LEAD DISLODGE MENT	2	1% (2)	2	1% (2)	2	1% (2)	0	0% (0)
CONCOMITANT DEVICE INTERACTION	1	1% (1)	0	0% (0)	1	1% (1)	1	1% (1)
ELEVATED TRANSAMINASE	1	1% (1)	1	1% (1)	0	0% (0)	0	0% (0)
EXTRA-RESPIRATORY STIMULATION	1	1% (1)	0	0% (0)	0	0% (0)	1	1% (1)
IMPLANT SITE HEMATOMA	1	1% (1)	1	1% (1)	0	0% (0)	0	0% (0)
LEAD COMPONENT FAILURE	1	1% (1)	0	0% (0)	1	1% (1)	0	0% (0)
LEAD DISPLACEMENT	1	1% (1)	1	1% (1)	1	1% (1)	0	0% (0)
NON-CARDIAC CHEST PAIN	1	1% (1)	1	1% (1)	0	0% (0)	0	0% (0)

¹Relationship defined as probably or definitely related.
²Events and subjects with events may be counted as implant procedure, system and therapy related so may not add up to the combined events or subjects.

1.9.4.1.2 Non-Serious Related Adverse Events

Forty-eight percent (48%) of subjects experienced a non-serious event related to the implant procedure, the remedē® System or delivered therapy. **Table 4** displays the number of each type of event reported, the number and percentage of subjects who experienced the events, and the relationship of the event to the implant procedure, the remedē System or delivered therapy.

Table 4 Summary of Related non-Serious Adverse Events and Observations through 12 Months

EVENT	Pooled (N=151)							
	Implant, System and/or Therapy Related ^{1,2}		Implant Procedure Related		System Related		Delivered Therapy Related	
	n Events	% (n) Subjects	n Events	% (n) Subjects	n Events	% (n) Subjects	n Events	% (n) Subjects
ANY EVENT	105	48% (73)	30	17% (25)	11	7% (11)	67	35% (53)
DIAPHRAGMATIC STIMULATION DISCOMFORT	48	25% (38)	0	0% (0)	1	1% (1)	48	25% (38)
EXTRA-RESPIRATORY STIMULATION	15	9% (14)	0	0% (0)	0	0% (0)	15	9% (14)
IMPLANT SITE PAIN	7	5% (7)	7	5% (7)	0	0% (0)	0	0% (0)
IMPLANT SITE HEMATOMA	5	3% (4)	5	3% (4)	0	0% (0)	0	0% (0)
IMPLANT SITE BRUISING	4	3% (4)	4	3% (4)	0	0% (0)	0	0% (0)
ELEVATED LEAD IMPEDANCE	3	2% (3)	1	1% (1)	3	2% (3)	0	0% (0)
ELEVATED THRESHOLDS	2	1% (2)	0	0% (0)	2	1% (2)	0	0% (0)
IMPLANT SITE INFLAMMATION	2	1% (2)	2	1% (2)	0	0% (0)	0	0% (0)
INSOMNIA	2	1% (2)	0	0% (0)	0	0% (0)	2	1% (2)
PROGRAMMING ERROR	2	1% (2)	0	0% (0)	1	1% (1)	1	1% (1)
VENOUS THROMBOSIS	2	1% (2)	0	0% (0)	2	1% (2)	0	0% (0)
BACK PAIN	1	1% (1)	1	1% (1)	0	0% (0)	0	0% (0)
CONCOMITANT DEVICE INTERACTION	1	1% (1)	0	0% (0)	0	0% (0)	1	1% (1)
DIARRHEA	1	1% (1)	1	1% (1)	0	0% (0)	0	0% (0)

Table 4 Summary of Related non-Serious Adverse Events and Observations through 12 Months

EVENT	Pooled (N=151)							
	Implant, System and/or Therapy Related ^{1,2}		Implant Procedure Related		System Related		Delivered Therapy Related	
	n Events	% (n) Subjects	n Events	% (n) Subjects	n Events	% (n) Subjects	n Events	% (n) Subjects
DISSECTION OF SUBCLAVIAN VEIN	1	1% (1)	1	1% (1)	0	0% (0)	0	0% (0)
HYPOXIA	1	1% (1)	1	1% (1)	0	0% (0)	0	0% (0)
IMPLANT SITE ERYTHEMA	1	1% (1)	1	1% (1)	0	0% (0)	0	0% (0)
IMPLANT SITE INFECTION	1	1% (1)	1	1% (1)	0	0% (0)	0	0% (0)
IMPLANT SITE SWELLING	1	1% (1)	1	1% (1)	0	0% (0)	0	0% (0)
INADEQUATE LEAD POSITION	1	1% (1)	1	1% (1)	0	0% (0)	0	0% (0)
LEAD DISLODGE MENT	1	1% (1)	1	1% (1)	1	1% (1)	0	0% (0)
LEAD DISPLACEMENT	1	1% (1)	0	0% (0)	1	1% (1)	0	0% (0)
SUTURE IRRITATION	1	1% (1)	1	1% (1)	0	0% (0)	0	0% (0)
URTICARIA	1	1% (1)	1	1% (1)	0	0% (0)	0	0% (0)

¹Relationship defined as probably or definitely related.
²Events and subjects with events may be counted as implant procedure, system and therapy related so may not add up to the combined events or subjects.

1.9.4.1.3 System Explants

Explants of the **remedē**® System occurred in 5.3% (8/151) of subjects. Details are provided in [Table 5](#).

Table 5 Summary of System Explants

Number of Subjects	Reason for System Explant
2	Investigational device implant site infection
2	Elective explant ¹
1	Device battery depletion – expected
1	Lead component failure ²
1	ICD pocket infection (ICD and remedē System shared a common venous entry point requiring explant of both systems)
1	Failed stimulation lead modification procedure
¹ One subject chose to exit due to an intervening medical condition (depression) and one subject withdrew consent and requested a system explant ² Failure of one constituent part of the lead	

1.9.4.1.4 Trial Withdrawals

A total of 43 subjects had exited the trial as of the datalock. [Table 6](#) displays the reasons for trial discontinuation.

Table 6 Summary of Reasons for Trial Withdrawals

Exit reason	Treatment (N=73)	Control (N=78)	Pooled (N=151)
	% (n) Subjects	% (n) Subjects	% (n) Subjects
Physician-initiated withdrawal	1% (1)	3% (2)	2% (3)
Subject Death	15% (11)	14% (11)	15% (22)
Subject Lost to Follow-Up	1% (1)	1% (1)	1% (2)
Subject-initiated withdrawal	8% (6)	5% (4)	7% (10)
System explanted ¹	7% (5)	1% (1)	4% (6)
Total	33% (24)	24% (19)	28% (43)
¹ 2 subject-initiated withdrawals also underwent system explant			

Subjects exited for the following reasons:

- Physician-initiated withdrawals for three (3) subjects
 - Two (2) due to intervening medical conditions
 - One (1) exit from the trial subsequent to a failed implant attempt
- Subject death for 22 subjects
- Lost to follow-up for two (2) subjects
 - One (1) subject after an unsuccessful implant attempt
 - One (1) subject became unreachable despite multiple attempts by the investigational site to contact the subject

Note: Neither subject had therapy initiated at the time of being lost to follow-up

- Subject-initiated withdrawals for ten (10) subjects
 - Five (5) subjects withdrew due to intervening medical issues
 - Three (3) subjects withdrew due to relocating away from study site
 - Two (2) withdrew consent subsequent to failed implant attempts
- Withdrawal due to explanted **remedē**[®] Systems occurred in six (6) subjects. Two (2) subject-initiated withdrawals also had the system explanted as outlined in Section 1.9.4.1.3

1.9.4.2 Effectiveness

The primary effectiveness endpoint was a comparison of the proportions of patients in the treatment versus control groups achieving a reduction in AHI of $\geq 50\%$ from baseline to 6 months. The proportion of patients achieving $\geq 50\%$ reduction in AHI and the 95% confidence interval (CI) for the Treatment group was 51% (35/68) [95% CI (39%, 64%)] compared to 11% (8/73) [95% CI (5%, 20%)] for the Control group, resulting in a difference of 41% [95% CI (25%, 54%)] (**Table 7**). This result was statistically significant ($p < .0001$), demonstrating that active therapy with the **remedē** System is superior to Control (inactive therapy) in achieving a 50% reduction in AHI.

Table 7 Summary of the Comparison of the Proportion of Patients with $\geq 50\%$ Reduction in AHI at 6 Months (Modified ITT)

Variable	Treatment ¹	Control	Difference	P-value ²
AHI reduced $\geq 50\%$	51% (35/68) (39%, 64%)	11% (8/73) (5%, 20%)	41% (25%, 54%)	<.0001
Percent (n/N) and 95% Exact Confidence Interval.				
¹ Includes 7 patients imputed as not achieving $\geq 50\%$ reduction in AHI.				
² P-value from 1-sided Fisher's Exact Test.				

1.9.4.3 Conclusion

The data support the reasonable assurance of safety and effectiveness of this device for treatment of moderate to severe CSA in adults.

1.10 Storage and Handling

The IPG and stimulation leads are sterilized with ethylene oxide (EtO) prior to shipment.

The materials used are biologically compatible, but they are nevertheless prone to attract foreign particles. Avoid any contamination before introduction of the IPG or leads into the body.

Inspect the sterile package and contents prior to opening to ensure it is intact and contains a proper sterile use by date. The IPG, stimulation leads, and packaged accessories are intended for one (1) time use only and cannot be resterilized, do not implant product from a damaged or opened package.

Store and transport the **remedē**® System in a dry place and within the recommended environmental temperature limits displayed in **Table 8** below.

Table 8 Environmental Temperature Limits

remedē® System	Temperature Ranges
remedē IPG	0°C (32°F) and 50°C (122°F)
respistim® R, L, LQ, LQS Leads	5°C (41°F) and 30°C (86°F)
remedē System Programmer	-20°C (-4°F) and 70°C (158°F)
Programming Wand	-20°C (-4°F) and 70°C (158°F)
eIPG	0°C (32°F) and 50°C (122°F)

Do not implant the IPG if it has been dropped on a hard surface from a height of 30 cm (12 in) or greater.

Only appropriate sterile implant techniques should be used to handle the **remedē** System once removed from the sterile packaging.

1.10.1 Stimulation Leads

Avoid severe bending, kinking, stretching or aggressive handling with surgical instruments as this may cause permanent damage to the lead. Only appropriate sterile implant techniques should be used to handle the stimulation lead once removed from sterile packaging.

Published literature suggests that certain upper extremity activities can cause damage to the leads and possible failure of the leads. Active people, particularly those who perform repetitive upper extremity exercise at work or play should be cautioned that they could subject leads to damaging stress.

1.11 Clinician Training

Prior to implanting the **remedē** System, implanting physicians will receive instruction on implant tools and techniques, anatomical considerations, and instruction on concomitant device testing. Clinicians will receive training related to therapy management including the initiation of therapy, titration, and use of the programmer.

1.12 remedē[®] System Implant

This section describes the general implant procedure of the **remedē** System. Both **respistim** L (left) and **respistim** R (right) stimulation lead placements described in 1.11.3.2 have been shown to be equally effective and safe. Similar to cardiac device transvenous lead implant procedures, the implanting physician will determine the appropriate stimulation lead placement based on visualizing the anatomy under fluoroscopy, gaining access to the vessels, navigating the lead to a stable location within the desired vessel, and electrically stimulating the nerve. Provided the anatomy is suitable for a **respistim** L (left) lead placement, the physician should attempt to place this lead since the **remedē** IPG battery longevity is typically greater with this system configuration.

1.12.1 Mitigation Strategies for Managing the Risk of Infection During remedē[®] System Implant, Replacement and Explant Procedures

The following recommendations should be followed in order to minimize the risk of infection during the **remedē** System implant, replacement and explant procedures.

- Use rigorous aseptic methods including antiseptic skin preparation
- Administer prophylactic and post-operative antibiotics
- Use antiseptic flush in the pocket
- Use local antimicrobial agents

1.12.2 Implantable System

- **remedē** System IPG
- **respistim**[®] L, LQ, LQS, or R stimulation lead
- IS-1 compatible bipolar transvenous lead for sensing (if applicable)

1.12.3 remedē[®] System Implant Procedure

The **remedē** System Implant includes the following steps:

- Locate target vessel and deploy the stimulation lead
- Test for phrenic nerve capture and secure the stimulation lead
- Deploy the sensing lead (if applicable)
- Perform final testing
- Create pocket, insert leads into the IPG and secure the IPG in the pocket
- Concomitant testing (if applicable)

1.12.3.1 Locate the Target Vessel

- Gain venous access using the right axillary, cephalic or subclavian vein using standard techniques.
- Select a puncture site near the lateral border of the first rib when utilizing a subclavian approach and avoid penetrating the subclavius muscle

Caution: Do not insert the lead under the medial one-third region of the clavicle; lead damage from clavicle/first rib entrapment or chronic dislodgment of the lead is possible if the lead is implanted in this manner. It is recommended to introduce the lead into the subclavian vein near the lateral border of the first rib.

- Insert a guiding catheter to provide guidewire support. Refer to [Figure 8](#) below for a pictorial description of typical venous anatomy.
- Obtain a venogram to visualize target vein ostium.

Caution: When locating the target vein ostium with the guiding catheter, do not force the catheter tip forward if resistance is felt.

Caution: Excessive amount and/or rate of contrast dye injection can cause extravasation of contrast dye or vessel dissection.

- Cannulate the vein and visualize with selective venogram (for the left pericardiophrenic vein).

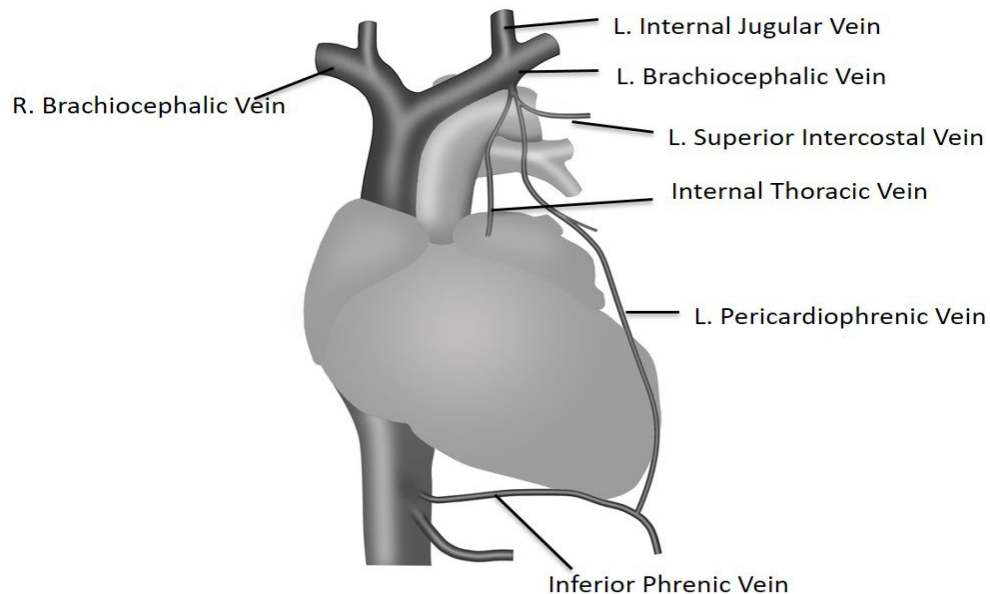

Figure 8 Typical Left Pericardiophrenic Vein Anatomy

1.12.3.2 Deploy the Left or Right Stimulation Lead

1.12.3.2.1 Left Pericardiophrenic Stimulation Lead

- Insert respistim® L, LQ, or LQS stimulation lead over a 0.014 inch guide wire and advance to desired position within the left pericardiophrenic vein
- Use care when inserting a guide wire into the lead to avoid penetrating the lead wall or damaging the lead conductor coil.

Note: Flushing a clotted lead can compromise the integrity of the stimulation lead. If clotting is suspected, remove the lead from the body and soak in heparinized saline. Insert a guide wire into the proximal or distal end of the stimulation lead and advance to clear the lumen.

Note: Guide wires should be handled with care at all times. A damaged guide wire may not behave as expected and could result in damage to the lead or vasculature.

1.12.3.2.2 Right Brachiocephalic Stimulation Lead

- Select the appropriate right stimulation lead model for the diameter of the brachiocephalic vein (See Appendix III). A lead that is too small for the vessel can result in weak or ineffective diaphragmatic stimulation
- Ensure the stylet is fully advanced within the lead to the distal end of the lumen before inserting the right stimulation lead
- Use care when inserting the stylet to avoid damaging the lead wall or conductor coil. It may be necessary to straighten the helical shape of the lead to fully advance the stylet
- Place the lead through an introducer sheath and advance until the distal end of the lead is at the level of the superior vena cava or right atrium
- Retract the stylet gradually and apply counterclockwise rotation to the lead body to allow the helical shape to form
- Apply gentle traction and counterclockwise rotation as needed to position the electrodes along the lateral wall of the vessel
- Do not allow the proximal and distal helices to collapse and make contact as this will not provide a stable lead position
- Assess the stability of the lead position by requesting that the patient breathe deeply or cough during fluoroscopic observation

Note: Motion of the lead synchronous with cardiac systole may suggest that the lead is near the right atrium and should be repositioned.

1.12.3.3 Test for Phrenic Nerve Capture

Patient stimulation testing requires communication with the patient to ensure an appropriate stimulation response. Physicians should deliver procedural sedation that allows for this

communication. See [Table 9](#) below for recommended stimulation threshold and impedance values.

1.12.3.3.1 Using the Lead Adapter with respistim Leads with In-line Terminals

The Lead Test Adapter (Model 1007) must be used to interface with the In-line terminals of respistim leads during phrenic nerve capture testing. The lead adapter permits electrical connection to lead electrodes for testing lead impedance and stimulation threshold of phrenic nerve capture. Leads with IS-1 terminals do not require the Lead Adapter during capture testing.

Prior to using the lead adapter make sure it is in the open position as shown by the black oval indicator ([Figure 9](#)).

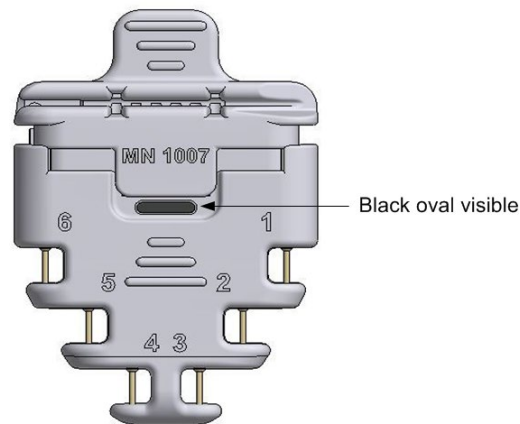

Figure 9 Lead Adapter in the Open Position

Lay the guide wire (respistim LQ/LQS lead) or stylet (respistim R leads) into the adapter using the slot provided. Insert the In-line terminal pin into the lead adapter port. Confirm complete insertion by visualizing terminal pin electrodes 1 and 6 through the windows provided ([Figure 10](#)).

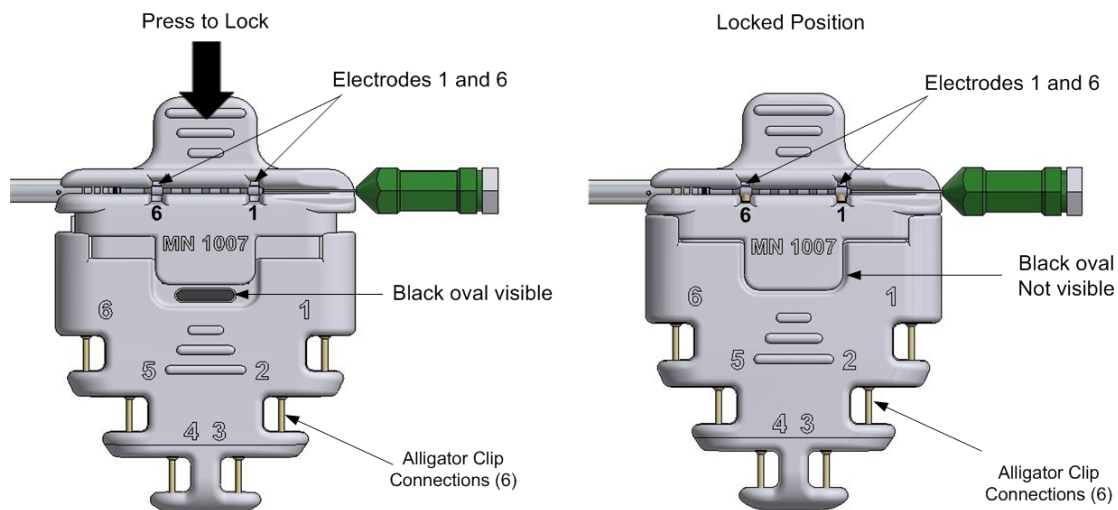

Figure 10 Visualizing terminal pin electrodes 1 and 6 through windows

Lock the In-line terminal pin in place by pressing down on the tab (above left) as shown in **Figure 10**; the black oval indicator will no longer be visible (above right).

To remove In-line terminal pin from Lead Adapter pull up on the tab until the black oval indicator becomes visible and pull the respistim lead from Lead Adapter port.

1.12.3.3.2 Testing for Capture

- Once the stimulation lead has been placed in the desired location, make sure the stylet or guide wire is retracted sufficiently to expose lead bias, if applicable, allowing the lead to engage the vessel in a natural way.
- Attach the Lead Adaptor if implanting an LQ, LQS or R lead with the In-line terminal pin
- Select an electrode testing configuration (cathode-anode electrode pair) and connect the stimulation lead to the **remedē**® eIPG
- **Caution:** Connect the sterile cable to the **remedē** eIPG before connecting to the IS-1 stimulation lead terminal pin or the Lead Adaptor if implanting a lead with the In-line terminal pin.
 - Caution:** Do not touch the exposed metal of the stimulation lead terminal pin or the exposed metal of the lead adaptor or cable alligator clips. Do not allow the exposed metal of the stimulation lead terminal pin or the exposed metal of the lead adaptor or cable alligator clips to contact electrically conductive or wet surfaces.
 - Caution:** Protect any unused alligator clip(s) from contact with any conductive surface or current leakage source.
- Set the eIPG stimulation amplitude, pulse width and frequency based on the stimulation lead implanted
 - respistim® L, LQ, LQS (left) stimulation lead
 - Amplitude = 2 mA
 - Pulse Width = 150 µsec
 - Frequency = 20 Hz
 - respistim® R (right) stimulation lead
 - Amplitude = 5 mA
 - Pulse Width = 300 µsec
 - Frequency = 40 Hz
- Deliver a single test pulse
- Increase or decrease the stimulation current incrementally as needed until a moderately strong diaphragmatic contraction is observed by means of abdominal palpation or fluoroscopic visualization
 - If an inadequate response or no response is detected, the implanting physician should select a new electrode pair (for R, LQ and LQS leads) and repeat the stimulation threshold test before repositioning the stimulation lead

- If an inadequate or no response persists, the stimulation lead should be repositioned and the stimulation threshold test sequence repeated until the desired response is achieved
- Test for extra respiratory sensations (ERS) at levels above the stimulation threshold
 - ERS or sensations during stimulation other than diaphragmatic contraction are the result of stimulating nerves beyond the phrenic nerve
 - Reposition the lead if unable to avoid ERS through electrode selection or limitation of IPG output
- Remove the lead adaptor when testing is complete

Table 9 Recommended Stimulation Threshold and Impedance Values

Stimulation Lead	Stimulation Threshold	Stimulation Lead Impedance	Criteria for stimulation threshold
Left	<4mA	400 – 2000 Ω	Clear evidence of diaphragmatic movement determined via palpation or fluoroscopy
Right	<5mA	200 – 800 Ω	

1.12.3.4 Secure the Stimulation Lead

- The guiding catheter (respistim[®] L, LQ or LQS) or introducer sheath (respistim[®] R) must be removed prior to securing the stimulation lead. For detailed instructions on removing the guiding catheter refer to the manufacturer’s Instructions For Use (IFU).
- Ensure sufficient lead slack is provided within the venous system to allow for strain relief during changes in body position to reduce the risk of lead dislodgement.
- Position the first ligature sleeve immediately proximal to the point of venous access and secure the ligature sleeve to the lead using permanent, non-absorbable sutures; anchor the ligature sleeve to the fascia or other suitable subcutaneous tissue using permanent, non-absorbable sutures.
- For respistim R leads, place a second suture sleeve a minimum of 10 cm proximal to the first suture sleeve with a strain relief loop between the first and second sleeve for stability.
- Maintain the guide wire or stylet within the lumen of the stimulation lead while securing the ligature sleeve to the lead body and anchoring to tissue in order to prevent damage to the stimulation lead insulation and conductor coil.
- Do not use excessive force when tying sutures on ligature sleeves.
- Do not kink, twist, or torque the lead while anchoring the ligature sleeve, as doing so could cause electrode movement.
- Do not tie a suture directly to the lead body.

Note: Inadequate strain relief between proximal and distal ligature sleeves (if multiple ligature sleeves are present) or between ligature sleeve and IPG pocket can increase the risk of chronic flex damage to the lead.

1.12.3.5 Deploy Sensing Lead (if applicable)

- Deploy the sensing lead into a branch vein off the main tributary of the azygos vein using standard techniques

Note: The respistim lead or any commercially available bipolar IS-1 compatible lead can be utilized for sensing

Note: remedē IPG Model 1600 senses from the stimulation lead and does not have a connector port for a dedicated sensing lead.

1.12.3.6 Create Pocket, Insert Leads and Secure IPG

Note: For optimal performance of the 3-axis position sensor, care should be taken to ensure the pocket is tight forming and **aligned vertically** (**Figure 11**).

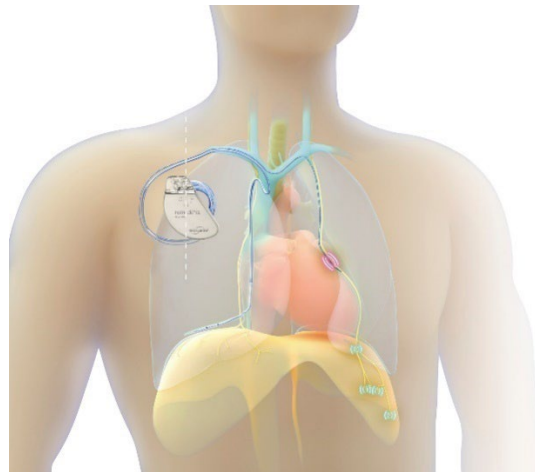

Figure 11 Recommended IPG Pocket Location

1.12.3.7 IPG Connections

The remedē IPG makes connection with stimulation leads and optional sensing lead by way of connector ports in the header block. These connections should be made carefully by fully inserting the terminal pin into the connector port and tightening setscrews with the appropriate wrench.

1.12.3.7.1 IPG Model 1001/1100

The **remedē** IPG Model 1001 and 1100 has four IS-1 bipolar connector ports in the header block, three for connecting stimulation leads and one for an optional sensing lead. The three stimulation lead ports are labeled **1-2**, **3-4** and **5-6** corresponding to the following stimulation lead electrodes (**Figure 12**). The single IS-1 bipolar connector sensing lead port is labeled **S** and allows for the insertion of a bipolar sensing lead (also **Figure 12**):

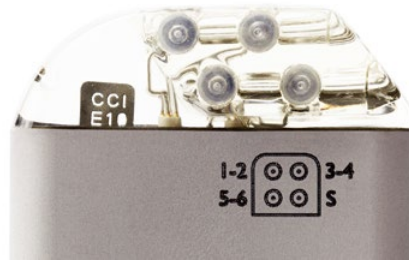

Figure 12 The **remedē**® IPG Connector Block and Port Diagram

- 1-2 corresponds to electrode 1 (distal) and electrode 2
- 3-4 corresponds to electrode 3 and electrode 4
- 5-6 corresponds to electrode 5 and electrode 6 (proximal)
- S corresponds to the sensing lead

Note: For easier lead insertion, insert terminal S into Sense IS-1 and lower stimulation port (5-6) IS-1 connectors first.

The distal end electrodes of the **respistim** L Stimulation Lead correspond to the IS-1 connections detailed in **Figure 13** with electrode 1 being the most distal electrode and electrode 2 being the most proximal electrode.



Figure 13 **respistim**® L Stimulation Lead Connections

The electrodes of the **respistim** LQ and LQS Stimulation Leads correspond to the IS-1 connections shown in **Figure 14** with electrode 1 being the most distal electrode and electrode 4 being the most proximal electrode. The IS-1 terminal containing the serial number marking corresponds to electrode 1-2.

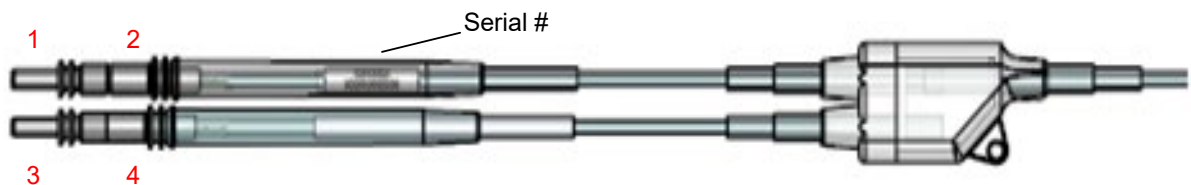

Figure 14 **respistim**® LQ and LQS Stimulation Lead Connections

The electrodes of the respistim® R Stimulation Leads correspond to the IS-1 connections shown in **Figure 15** with electrode 1 being the most distal electrode and electrode 6 being the most proximal electrode. The IS-1 terminal containing the serial number marking corresponds to electrode 1-2.

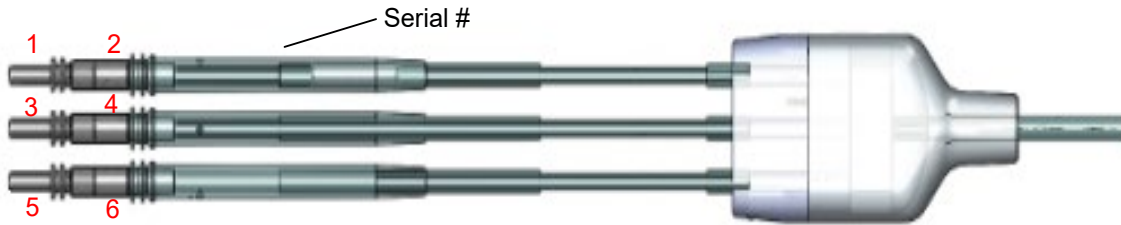

Figure 15 respistim® R Stimulation Lead Connections

Note: Insert the IS-1 lead terminal pins to a depth such that the pin fills more than 50% of tip cavity as shown in **Figure 16**. Tighten all set screws with the white handle torque wrench provided with the IPG.

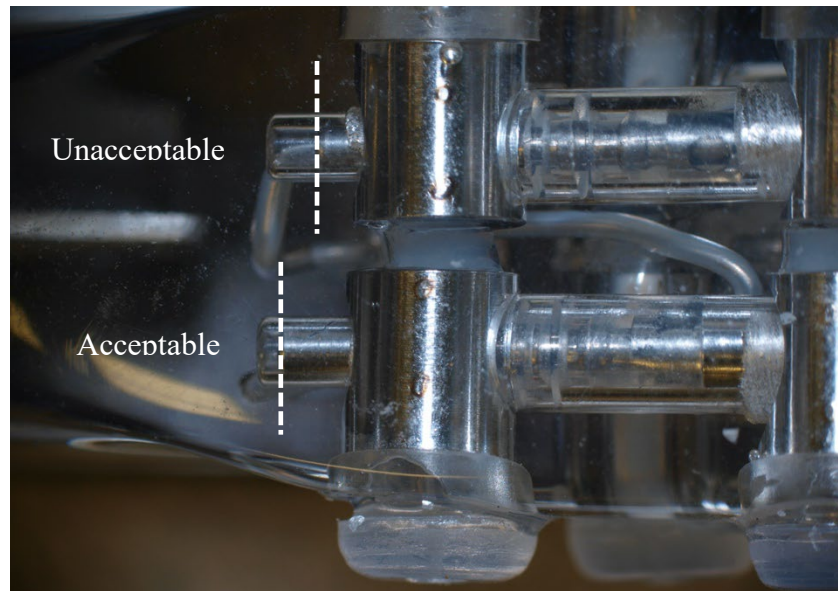

Figure 16 IS-1 IPG/terminal Pin Connections-Acceptable and Unacceptable pin depth

1.12.3.7.2 IPG Model 1600

The **remedē** IPG Model 1600 has one In-line connector port in the header block for connecting the respistim LQ, LQS or R In-line stimulation lead. The stimulation lead port is marked **1 6** corresponding to stimulation lead electrodes (**Figure 17**).

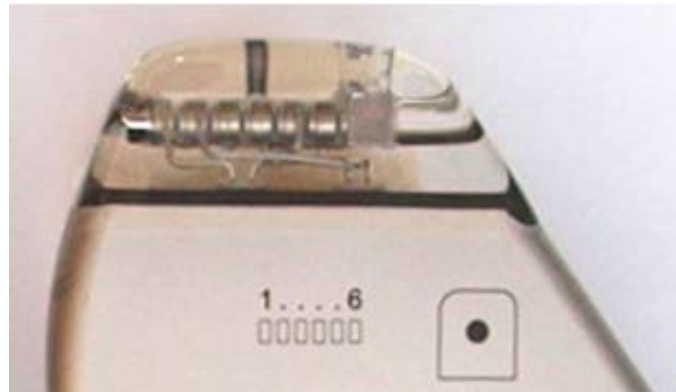

Figure 17 The remedē® IPG Connector Block and Port Diagram

The electrodes of the respistim LQ, LQS, and R Stimulation Leads correspond to the In-line Terminal Pin connections detailed in **Figure 18**. Electrode 1 is the most distal electrode of the lead and connects with terminal contact 1. Electrode 6 is the most proximal electrode of the lead and it connects with terminal contact 6. For the respistim LQ/LQS quadripolar leads, terminal contacts 5 and 6 are electrically inactive since there are only 4 electrodes on the lead. The retention ring is where the set screw secures the terminal in the connector port and is electrically inactive.

Note: Insert the In-line lead terminal such that the laser band marking is no longer visible through the IPG header epoxy. The In-line terminal is fully inserted when the laser band is no longer visible.

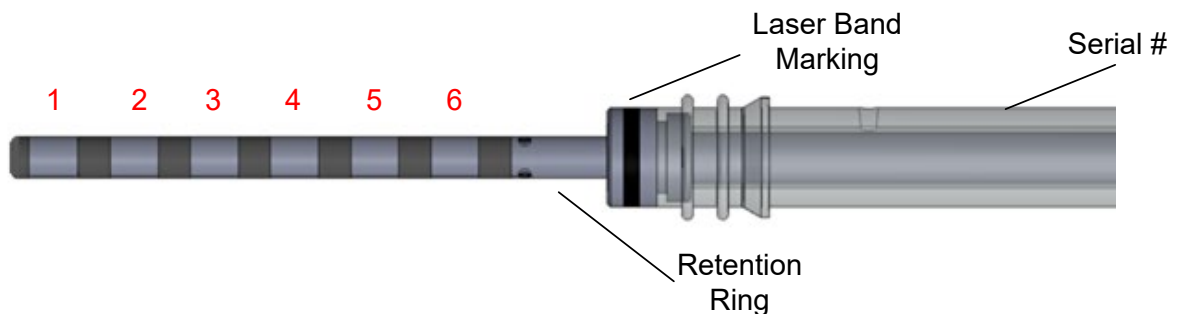

Figure 18 The respistim In-line Terminal Pin

Tighten the set screw with the torque wrench provided with the IPG. The In-line wrench is demarcated by its green end (**Figure 19**).



Figure 19 Tighten setscrew using the green In-line Torque Wrench

Caution: Verify that the lead connections are secure. Loose lead connections may result in inappropriate sensing and/or failure to deliver stimulation therapy.

Caution: Use only the wrench supplied with the device, Green for the In-line stimulation leads. The wrench is designed to prevent damage to the device from over tightening a setscrew.

Caution: Counterclockwise rotation of a set screw may cause the set screw to disengage from the connector block.

Caution: If a multipolar stimulation lead is not implanted, pin plugs must be secured in the unused stimulation ports to avoid damage to the device.

- Minimize potential for lead-to-lead and lead-to-can contact by not kinking, twisting, or braiding any portion of the lead with other leads, as doing so could cause lead insulation abrasion or conductor damage.
- Do not bend the lead near the lead-header interface. Improper insertion can cause insulation or connector damage.
- **Prior to placing the IPG in the pocket**, wrap any excess lead length loosely behind the IPG by rotating as shown in **Figure 20**.
- Place the IPG and excess lead wrap in the IPG pocket with the IPG connector closest to the pocket incision and with the **device labeling facing up toward the skin**.
- Do not coil the leads. Coiling will twist the lead bodies and may result in lead dislodgment.



Figure 20 Proper Rotation of IPG to Wrap Excess Lead Length

- Test lead impedance **after** connecting the leads to the IPG
- **Secure the remedē® IPG in the pocket** in order to minimize the risk of migration and mechanical interaction with the lead

1.12.4 Concomitant Cardiac Device Testing (if applicable)

Testing for concomitant cardiac device interaction at the time of **remedē** System implant for patients with a pre-existing cardiac device is recommended. Concomitant device interaction testing should be repeated prior to therapy initiation and anytime the **remedē** System or the cardiac device system is modified. The following steps are required to complete concomitant device interaction testing:

1. Disable high voltage cardiac therapies on the cardiac device if applicable
2. Program cardiac device sensing to the most sensitive setting and prepare for monitoring electrogram (EGM) and device marker channels
3. Set up **remedē**® System stimulation test (2 sec duration)
 - a. Acute/new **remedē** System:
 - i. Left stimulation lead: pulse width 150µs, frequency 20 Hertz
 - ii. Right stimulation lead: pulse width 300µs, frequency 40 Hertz
 - b. Chronic **remedē** System:
 - i. Use programmed pulse width and frequency settings
4. Deliver 2-3 stimulation pulses at 2 times the stimulation threshold
5. Observe cardiac device EGM and marker channels for evidence of detection of **remedē** System stimulation pulses
6. Testing should be completed with both an intrinsic (sensed) rhythm and during forced ventricular pacing

1.12.5 Postoperative Care

Follow up according to normal postoperative care procedures. A 7 to 14 day check of the surgical incision healing is recommended.

To allow for stabilization and healing after the implant procedure, the **remedē** System therapy should not be enabled for approximately 1 month following implant.

Regular patient follow-up should be scheduled to monitor the condition of the IPG battery and to confirm that therapy settings are appropriately programmed.

Intermittent or continuous loss of stimulation or sensing can be caused by a displacement of the electrode, unsatisfactory electrode position, breakage of the conductor or its insulation, an increase in thresholds, or poor electrical connection to the pulse generator.

1.12.6 Physician Instructions to Patient

Information regarding the **remedē** System should be provided to patients including the warnings and precautions provided on page 13. Patients should also be instructed as follows:

- It is normal to feel some discomfort from the surgical incision and to have some pain at the implant site for 2 – 6 weeks.
- It is best to limit the mobility of the right arm (or left arm if left-sided device placement) and avoid lifting the arm above shoulder level for several weeks after the implant procedure. This time period allows the leads and IPG to affix more securely in place and such movements could impair the healing process.
- Repetitive upper extremity activities and exercise can cause damaging stress and possible failure to permanent implanted leads. Active patients should be cautioned to avoid physical activities that could damage the implant site or the implanted system.
- Inform general practitioners and consulting physicians that the patient has an implanted stimulation system
- Carry the Device/Subject Identification Card at all times

1.12.7 Patient Registration

Complete a **remedē**[®] System registration form following implant of the **remedē** System. This form serves as a permanent record of facts related to the implanted system. A copy of this form should be returned to ZOLL Respocardia, Inc. Refer to the last page of this manual for contact information.

1.12.8 Surgical Revision and Explant

1.12.8.1 Lead Repositioning

If the stimulation lead becomes displaced and phrenic nerve capture cannot be obtained by programming stimulus to other electrodes, an effort to reposition the affected lead should be attempted as soon as possible. Care should be taken to avoid damage to the implanted IPG, stimulation lead, sensing lead and surrounding tissues during the replacement procedure. If the displaced lead is unable to be repositioned and must be explanted, the lead should be returned to ZOLL Respocardia, Inc. for analysis and/or disposal.

1.12.8.2 IPG Replacement

The IPG should be replaced when IPG battery has been depleted and either the elective replacement indicator (ERI) or end of life (EOL) indicator is displayed on the **remedē** System Programmer. Care should be taken to avoid damage to the implanted leads during the

replacement procedure. Confirm proper function and programming of the **remedē** System following replacement. The explanted IPG should be returned to ZOLL Respicardia, Inc. for analysis and/or disposal.

1.12.8.3 System Explant

The decision to remove the **remedē** System is the responsibility of the physician and patient and should be determined on a case by case basis. The risks associated with system removal and/or abandonment should be considered. If the IPG is removed but the leads are left in place, the proximal connectors of the leads should be capped to minimize tissue irritation and induced currents. Any explanted system components should be returned to ZOLL Respicardia, Inc. for analysis and/or disposal.

1.13 Using the remedē® System Programmer

1.13.1 remedē® System Programmer

The **remedē** System Programmer (**Figure 21**) includes:

- **remedē** System Programmer tablet display with **remedē** Programmer Software Application
- **remedē** System Programmer wand
- Medical grade power supply



Figure 21 remedē System Programmer Tablet Display (Model 1002A)

1.13.1.1 remedē® System Programmer Tablet

The System **remedē** Programmer tablet display is an interactive touch screen tablet controlled using the attached stylus. The external button and ports used for tablet operation and telemetry connectivity (On/Off button, USB port, and Power port) are labeled along the border of the tablet display as shown in **Figure 21**. The most common location on the tablet for the button/ports is

shown in **Figure 22** although not all tablet displays have the button/ports in the exact same location.



Figure 22 remedē System Programmer Tablet

Buttons/Ports: (1) Power input port/slot, (2) USB port – do not use for Wi Fi connection, (3) On/Off button, (4) Audio output port (unused), (5) SD memory slot with cover.

Note: Ports 1 and 2 are required for power and remedē System telemetry connectivity. The power input jack/slot may be plugged into the provided medical grade power supply.

1.13.1.2 remedē® System Programmer Wand

The remedē System Programmer wand (**Figure 23**) provides a communication link between the programmer tablet display and the device. The programming wand must be held over the device to interrogate or program. The programmer wand is connected to the programmer tablet display via the USB port.



Figure 23 The remedē System Programmer Wand

1.13.1.3 Medical Grade Power Supply

The **remedē** System Programmer is powered using the provided medical grade power supply and power cable.

Caution: – Use only the provided programmer power supply. Do not use the programmer power supply to power any other electronic devices. Never power the **remedē** System Programmer using an extension cord, power strip or other multiple outlet cable.

1.13.1.4 Connecting External Non-remedē Devices

Peripheral equipment connected to the programmer tablet display must be certified according to applicable International Electrotechnical Commission (IEC) standards for medical equipment. The system, formed by connecting peripheral equipment to the programmer, must comply with IEC 60601-1 for medical electrical systems. It is the responsibility of the user connecting the peripheral equipment to comply with IEC standards. It is the responsibility of the user to keep peripheral equipment that is certified to IEC 60950 at least two meters away from the patient. Contact the peripheral equipment manufacturer for information about IEC certification.

Caution: – To avoid a potential safety hazard, do not connect the **remedē** System Programmer to any non-certified outlet powered device (such as an external printer) during a patient session.

1.13.1.5 External USB/CAT5 Extension

An external USB/CAT5 extension kit may be used with the **remedē** System Programmer to allow for extended programmer use in a sleep lab control room during a sleep study (up to 150 ft. away from patient room). Use only an external USB/CAT5 extension kit that is compliant with IEC 60601-1 for medical electrical systems, compatible with USB 2.0 and provides power on the remote end of the extension.

1.13.2 Preparing for a Clinical Programming Session

1.13.2.1 Powering On the Programmer

The **remedē** System Programmer tablet display should be plugged in to an electrical outlet using the provided medical grade power supply. To power on the **remedē** System Programmer, press and hold the power button for at least 2 seconds until the tablet screen appears.

1.13.2.2 Starting the Software Application

Once the **remedē** System Programmer is powered on, the user should select the Respicardia **remedē** icon (**Figure 24**) from the desktop to start the **remedē** System Programmer Software (SW) Application. The version 4.5.0.6 software application is compatible with the Model 1001 IPG. The version 5.0.X.X software application is compatible with the Model 1100 and 1600 IPGs.



Programmer SW 4.5.0.6 Icon



Programmer SW 5.0.X.X Icon

Figure 24 Programmer SW 4.5.0.6 and Programmer SW 5.0.X.X Icons

If a user launches the **remedē** 5.0.X.X software application and attempts to communicate with a Model 1001 IPG, the application software will alert the user (**Figure 25**) that a different programmer application is needed and provide an option to automatically close **remedē** SW 5.0.X.X and launch the **remedē** SW 4.5.0.6 application that can interface with the Model 1001 IPG.

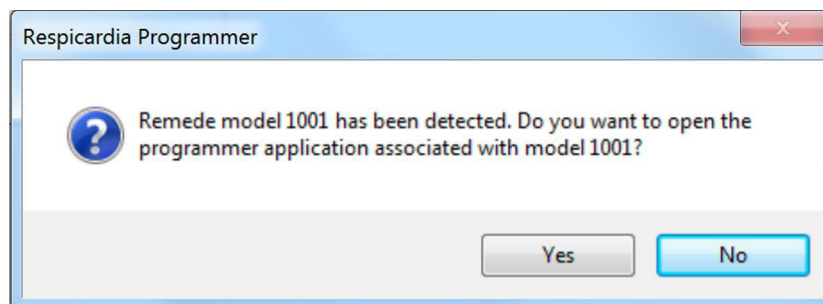

Figure 25 SW 5.0.X.X Alert if Attempting to Communicate with Model 1001 IPG

If a user launches the **remedē** SW 4.5.0.6 application and attempts to communicate with a Model 1100 or Model 1600 IPG, the application software will provide an alert (**Figure 26**) indicating that the user is attempting to communicate with an unknown device model.

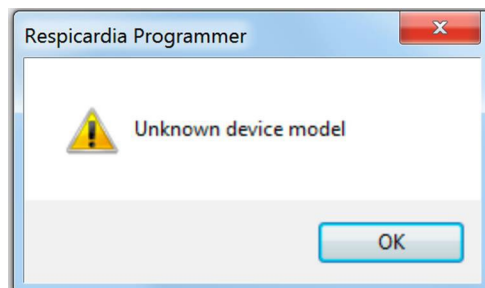

Figure 26 SW 4.5.0.6 Alert if Attempting to Communicate with Model 1100/1600 IPG

1.13.2.3 Navigating the Software Application



Figure 27 remedē System Software Application Screen

Title Bar

The title bar (Figure 27) is displayed at the top of the window. It identifies the software application currently running (**remedē Programmer**), the device serial number and displayed data source, which can be from an implanted device or a saved file set.

















Menu Bar

The Menu Bar (Figure 27) is displayed under the title bar. It contains the **remedē System Programmer** commands grouped under the File, View, Log, Tools and Help pull down menu headings. Selecting the Menu Bar item with the touch pen will open the corresponding pull down menu.

Toolbar

The toolbar (**Figure 27**) is displayed under the Menu Bar and offers shortcuts to frequently used functions from the File, Log, and Tools pull down menus from the Menu Bar. The toolbar also provides direct access to the mode to allow the user to quickly program between off, therapy and monitor modes. Selecting a button on the toolbar with the stylus will initiate the chosen task. See **Table 10** below for **remedē** System Software Application toolbar icons.

Table 10 remedē® System Software Application Toolbar Icons

	New Device		Read Impedance
	Open Saved Settings		Threshold Testing
	Print Current Settings		Activate Therapy
	Browse Current Log		Suspend Therapy
	Marker Detail		Set IPG Time
	Open Log File		Activity & Pitch Report
	Add Log Bookmark		Full Report
	Marker Mode		Urgent Off
	Travel Tool		

Parameter Window

The Parameter Window (**Figure 27**) contains all programmable parameters used to configure **remedē** System therapy. Once the **remedē** IPG is interrogated, the currently programmed settings are displayed in a tab format within the Parameter window. The parameters are grouped using a tab format with the following headings: Summary, Therapy, Stimulus, Weekly Titration, Nightly Titration, Sensors, Tools, Lab Parameters, Lab Status, and LOG Configuration. Selecting a tab heading will allow the user to view to the corresponding programmable parameters and their current values.

Programming Window

The Programming Window (**Figure 27**) allows a user to interrogate the device, directly execute a programming command and cancel pending programming changes that have not been executed or undo a previous programming command. A message field is located beneath the programming window buttons that details parameter value conflicts, if applicable.

Log Window

The Log Window (**Figure 27**) contains a message field detailing history log of all interactions between the device and programmer during a clinical programming session. Each log entry will contain the following format: description, status, date and time. The date and time correspond to the programmer clock. If the programmer clock is different from the clock maintained by the implanted device, a message will appear upon initial interrogation. If applicable, additional log entry information may be viewed by double tapping the specific log entry.

Marker Window

The Marker Window (**Figure 27**) may be used to graphically view live data collected by the device or to review previously collected waveforms and data. Two channels may be selected for viewing at a time.

Status Bar

The Status Bar (**Figure 27**) indicates any current communication event (for example, interrogation, programming and ready). The Status Bar may also be used to indicate the function of any buttons as the description will be displayed when the pointer is held over a button.

1.13.2.4 Positioning and Using the Programming Wand

During a clinical programming session, telemetry communication between the **remedē**[®] System Programmer and the **remedē** IPG requires the programming wand to be positioned over the patient's implanted device. The programming wand must be in place over the implanted device for the duration of the programming session. Lifting or moving the programming wand out of telemetry range will interrupt or end any tests or operations in progress. Replacing the wand may allow the user to resume progress saving wave or log data, while other functions may need to be restarted.

The programming wand contains a number of LEDs to indicate proper position and function. A green power on LED indicates the programming wand is connected to the **remedē** System Programmer display and powered. A series of red, yellow, and green LEDs indicate telemetry signal strength with green indicating best communication, yellow indicating adequate communication, and red or no LED illumination indicating poor or no communication. The programming wand should be repositioned in the case of red or no LED illumination.

Note: Best signal strength will be found when the distance between the Programming Wand and implanted device is less than 2.5 cm (1 inch).

1.13.2.4.1 Effect of Programming Wand on Concomitant Devices

The **remedē** System Programmer Wand does not contain a strong magnet. Placing the Programming Wand over a concomitantly implanted device is unlikely to have an effect on the operation and programming of the concomitant device.

1.13.2.5 Interrogating the **remedē**® IPG

Position the Programming Wand directly over the implanted device and verify sufficient signal strength for proper communication. Select the interrogate button from the **remedē** System Software Application (**Figure 28**) using the attached stylus or by selecting Interrogate under the File pull down menu on the Menu Bar. A common location on the software application screen for the interrogate button is shown in **Figure 28** although not all software application versions have the button in the exact same location. The interrogate button will illuminate in blue if no active programming session is in progress. After successfully completing the interrogation, the Summary Tab and associated parameters will appear displaying current device status and programmed settings.

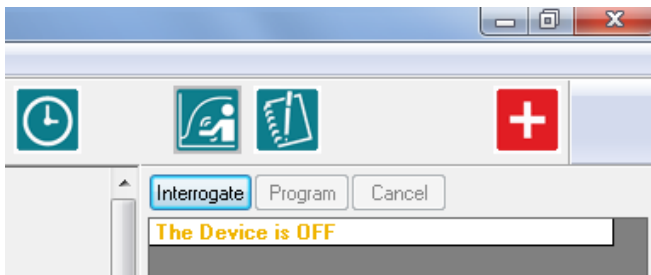

Figure 28 Interrogate Button

1.13.2.5.1 Battery Status

The measured battery voltage will be displayed, as shown in **Table 11**, with one of the following battery status indicator messages.

Table 11 Battery Status Indicator Level

Good	The measured battery voltage level is above the elective replacement indicator level.
ERI	The elective replacement indicator (ERI) is triggered after 3 consecutive battery measurements are less than 2.60V. The remedē IPG will continue to operate as programmed but replacement should be scheduled as soon as possible. Approximately 3.3 weeks of normal operation remain once ERI is triggered.
EOL	The end of life indicator (EOL) is triggered when 3 consecutive battery measurements are less than 2.50V. Stimulation therapy is disabled when the battery reaches EOL and the remedē IPG should be replaced immediately.

1.13.2.6 Urgent Off Command Using the Programming Wand

The urgent off command is a safety feature that overrides all functions in effect and immediately disables stimulation therapy and programs the device to the off mode. The urgent off command may be initiated using the programming wand by selecting and holding the urgent off button for at least 2 seconds (**Figure 29**). An orange LED above the urgent off button will illuminate and flash 5 times to indicate successful programming. If not successful, the programming wand will automatically make one additional attempt to program the urgent off command. In this case the user should ensure the programming wand is positioned over the device with sufficient telemetry signal strength.



Figure 29 remedē® System Programmer Wand Urgent Off Button

Once the **remedē** IPG has been interrogated, the user may also initiate the urgent off command by selecting Urgent Off from the Tools pull down menu on the Menu Bar or by selecting the urgent off icon from the toolbar (**Figure 27**).

Note: – The programming wand may be connected to any powered USB port to program the urgent off command and does not require the **remedē** System Software Application.

1.13.2.7 Therapy Suspension Using a Magnet

The **remedē**® System stimulation therapy can be suspended by placing a strong magnet over the implanted device (within 6 cm) in the event that the programming wand is unavailable. A magnetic sensor in the IPG can sense the presence of a strong, external magnetic field (most commonly generated by using a standard pacemaker donut magnet typically available in hospitals and also supplied with the **remedē** System Programmer). The minimum magnetic field strength required to activate the magnet sensor is 25 Gauss as measured at the surface of the **remedē** System device. The magnet must be held in place for a minimum of 10 seconds to allow the **remedē** System to detect the magnetic field and confirm its presence. Once a magnetic field has been detected, the **remedē** System automatically suspends stimulation therapy. Once the magnetic field has been removed, stimulation therapy will resume at the next Scheduled Sleep Start Time (typically the next night when stimulation therapy is scheduled to start).

1.13.2.8 Safe Mode

The **remedē** System may enter into Safe Mode if the IPG encounters an unknown condition or in the presence of a very large magnetic field such as an MRI machine. In Safe Mode, the **remedē**

System automatically suspends stimulation therapy until the IPG is interrogated and reset via the Programmer. Upon IPG interrogation, the **remedē** System Programmer will display an alert indicating the device has reverted to a secure mode (see example in **Figure 30**). The Implantable Device information on Programmer Summary tab will also list the Operating Mode as Safe as shown in **Figure 31** below. Please contact your **remedē** representative if the **remedē** IPG has entered into Safe Mode. The representative will return the IPG to normal operation and confirm proper functioning.

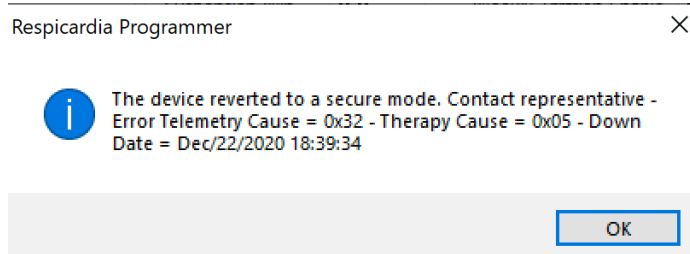

Figure 30 Example of Programmer alert when device has entered in Safe mode

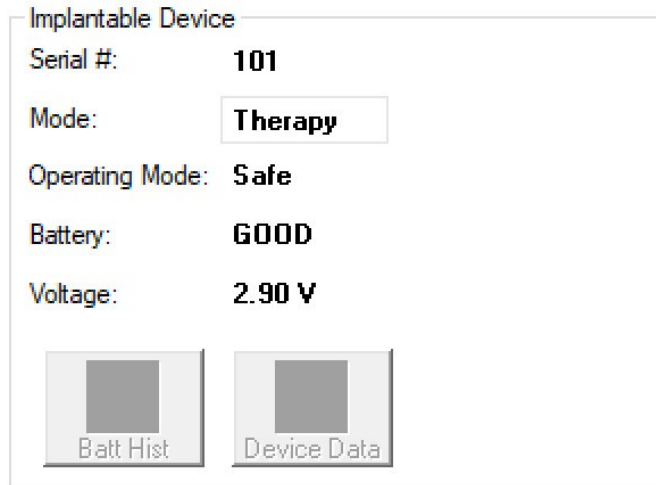

Figure 31 Summary tab display when Implantable Device is in Safe Mode

1.14 remedē[®] System Limited Warranty

A. LIMITED WARRANTY. ZOLL RESPICARDIA, INC. (“SELLER”) PROVIDES TO THE ORIGINAL PURCHASER OF THE PRODUCT (“BUYER”) THE FOLLOWING LIMITED WARRANTY FOR THE REMEDĒ[®] SYSTEM, COMPRISED OF THE IMPLANTABLE NEUROSTIMULATOR (“STIMULATOR”), WIRES FOR SENSING AND STIMULATION (“LEADS”), A PORTABLE HANDHELD TABLET (“TABLET”) A PATIENT WAND PROGRAMMING (“WAND”), AND THE PROPRIETARY REMEDĒ[®] SYSTEM MOBILE APP WHICH IS INSTALLED ON THE TABLET (“APP”). EACH OF THE STIMULATOR AND LEADS IS A “COMPONENT.” EACH OF THE TABLET AND WAND IS A “THIRD PARTY PRODUCT”.

I. (A) EACH COMPONENT AND THIRD PARTY PRODUCT OF A SYSTEM WHEN DELIVERED TO BUYER WILL BE NEW, OF HIGH QUALITY, AND FREE FROM MATERIAL DEFECTS AND CONSISTENT WITH THE DOCUMENTATION PROVIDED; AND (B) THE APP WILL PERFORM SUBSTANTIALLY IN ACCORDANCE WITH THE DOCUMENTATION ACCOMPANYING THE SYSTEM.

II. SHOULD THE APP FAIL TO PERFORM SUBSTANTIALLY IN ACCORDANCE WITH THE DOCUMENTATION WITHIN ONE YEAR, SELLER’S SOLE OBLIGATION AND BUYER’S SOLE REMEDY WILL BE FOR SELLER TO, AT ITS OPTION: (A) REPLACE OR REPAIR (INCLUDING AT SELLER’S OPTION BY REMOTE UPDATE) THE NON-CONFORMING APP OR ANY NON-CONFORMING PORTIONS THERETO WITH AN APP THAT CONFORMS TO THE DOCUMENTATION; OR (B) ISSUE A CREDIT TO BUYER. FOR CLARITY, THE APP IS LICENSED, NOT SOLD, TO BUYER, AND SELLER RETAINS ALL INTELLECTUAL PROPERTY RIGHTS IN AND TO THE APP.

III. SHOULD ANY COMPONENT FAIL TO FUNCTION WITHIN NORMAL USE DUE TO DEFECT IN MATERIALS OR WORKMANSHIP WITHIN A PERIOD OF TWO (2) YEARS COMMENCING WITH THE DELIVERY OF THE SUCH COMPONENT TO THE BUYER, SELLER’S SOLE OBLIGATION AND BUYER’S SOLE REMEDY WILL BE FOR SELLER TO, AT ITS OPTION (A) REPAIR OR REPLACE THE APPLICABLE COMPONENT; (B) PROVIDE A FUNCTIONALLY COMPARABLE REPLACEMENT COMPONENT AT NO CHARGE; OR (C) ISSUE A CREDIT TO BUYER. SHOULD ANY THIRD PARTY PRODUCT FAIL TO FUNCTION WITHIN NORMAL USE DUE TO DEFECT IN MATERIALS OR WORKMANSHIP WITHIN A PERIOD OF ONE (1) YEAR COMMENCING WITH THE DELIVERY OF THE SUCH THIRD PARTY PRODUCT TO THE BUYER, SELLER’S SOLE OBLIGATION AND BUYER’S SOLE REMEDY WILL BE FOR SELLER TO, AT ITS OPTION (A) REPAIR OR REPLACE THE APPLICABLE THIRD PARTY PRODUCT; (B) PROVIDE A FUNCTIONALLY COMPARABLE REPLACEMENT THIRD PARTY PRODUCT AT NO CHARGE; OR (C) ISSUE A CREDIT TO BUYER.

IV. IF SELLER CHOOSES TO ISSUE A CREDIT TO BUYER FOR A COMPONENT OR THIRD PARTY PRODUCT, THE CREDIT SHALL BE THE LESSER OF THE NET INVOICED PRICE OF THE ORIGINAL COMPONENT OR THIRD PARTY PRODUCT, OR THE CURRENT FUNCTIONALLY COMPARABLE COMPONENT OR THIRD PARTY PRODUCT OR REPLACEMENT COMPONENT OR THIRD PARTY PRODUCT. IF SELLER CHOOSES TO ISSUE A CREDIT TO BUYER FOR THE APP, THE CREDIT SHALL BE EQUAL TO THE FEES PAID FOR THE TABLET. FOR COMPONENTS OR THIRD PARTY PRODUCTS THAT

ARE USED WITH A SPECIFIC PATIENT, BUYER AGREES TO REFLECT THE CREDIT ON THE APPLICABLE PATIENT'S BILL AND REPORT THE CREDIT TO THE APPLICABLE PAYOR.

V. IN ORDER TO QUALIFY FOR THE LIMITED WARRANTY SET FORTH HEREIN, THE FOLLOWING CONDITIONS MUST BE MET: (A) THE COMPONENT OR THIRD PARTY PRODUCT MUST NOT HAVE BEEN REPAIRED OR ALTERED OUTSIDE OF SELLER'S FACILITY OR IN ANY WAY WHICH IN THE SOLE OPINION OF SELLER IMPACTS THE SYSTEM'S STABILITY AND RELIABILITY; (B) THE COMPONENT OR THIRD PARTY PRODUCT MUST NOT HAVE BEEN SUBJECT TO ABUSE, LACK OF PROPER MAINTENANCE, NEGLIGENCE, ACCIDENT, MOVEMENT, OR ADJUSTMENT OF EQUIPMENT BY PERSONNEL NOT AUTHORIZED BY SELLER; (C) THE COMPONENT OR THIRD PARTY PRODUCT MUST HAVE BEEN PUT INTO USE PRIOR TO ANY LABELED "USE BEFORE" DATE; (D) THE COMPONENT OR THIRD PARTY PRODUCT MUST HAVE BEEN USED IN ACCORDANCE WITH SELLER'S INSTRUCTIONS AND THE LABELING, AND MAY NOT HAVE BEEN USED FOR A PURPOSE NOT INDICATED ON THE LABELING; AND (E) NEITHER THE APP NOR ANY OTHER SOFTWARE OR FIRMWARE ON ANY COMPONENT OR THIRD PARTY PRODUCT MAY HAVE BEEN MODIFIED IN ANY WAY BY ANY PERSON OTHER THAN SELLER. FURTHERMORE, DEFECTS ARISING IN WHOLE OR PART AS A RESULT OF NORMAL WEAR AND USAGE, IMPROPER OR INADEQUATE MAINTENANCE, INTERRUPTIONS OR UNSUITABLE POWER OR COMMUNICATION SOURCES OR CONNECTIVITY, ENVIRONMENTAL CONDITIONS, ACCIDENT, MISUSE, ABUSE, IMPROPER INSTALLATION, MODIFICATION, REPAIR, STORAGE OR HANDLING, OR ANY OTHER CAUSE NOT THE FAULT OF SELLER ARE NOT COVERED BY THIS LIMITED WARRANTY.

VI. THE LIMITED WARRANTY DOES NOT APPLY TO EXPIRATION OF COMPONENT OR THIRD PARTY PRODUCTS PARTS WITH A LIMITED LIFETIME, SUCH AS THE BATTERY. SELLER HEREBY ASSIGNS TO BUYER ANY AND ALL MANUFACTURERS' OR SUPPLIERS' WARRANTIES, GUARANTEES, REPRESENTATIONS, SERVICES AGREEMENTS AND INDEMNITIES, APPLICABLE TO ANY THIRD PARTY HARDWARE OR SOFTWARE DELIVERED BY BUYER IN CONNECTION WITH THE SYSTEM, TO THE EXTENT ASSIGNABLE BY SELLER.

B. CLAIMING THE LIMITED WARRANTY. PLEASE CONTACT SELLER'S SERVICE DEPARTMENT OR THE AUTHORIZED REPRESENTATIVE BY MAIL OR PHONE PRIOR TO RETURNING A COMPONENT OR THIRD PARTY PRODUCT FOR FURTHER INSTRUCTIONS. WHEN RETURNING A COMPONENT OR THIRD PARTY PRODUCT, BUYER MUST INCLUDE A COMPLETE DESCRIPTION OF THE ALLEGED COMPONENT OR THIRD PARTY PRODUCT FAILURE ACCOMPANIED BY A PROOF OF PURCHASE ATTACHED TO THE COMPONENT OR THIRD PARTY PRODUCT. IN ORDER TO QUALIFY FOR THE LIMITED WARRANTY SET FORTH HEREIN, BUYER MUST RETURN THE COMPONENT OR THIRD PARTY PRODUCT TO SELLER WITHIN THIRTY (30) DAYS AFTER DISCOVERY OF DEFECT. SELLER WILL BEAR THE COSTS AND RISKS OF LOSS WITH ANY RETURN TRANSPORT TO SELLER. BUYER WILL BEAR THE COSTS AND RISKS OF THE RETURN TRANSPORT FOR REPLACEMENT OR REPAIRED COMPONENTS OR THIRD PARTY PRODUCTS, PROVIDED HOWEVER, THAT BUYER SHALL BE LIABLE TO SELLER FOR EXPENSES INCURRED IN CONNECTION WITH DIAGNOSING, REPAIRING AND/OR REPLACING ANY COMPONENT THIRD PARTY PRODUCT THAT WAS RETURNED OUTSIDE OF WARRANTY.

C. DISCLAIMERS AND LIMITATION OF LIABILITY. THE LIMITED WARRANTY IS LIMITED TO ITS EXPRESS TERMS. IN PARTICULAR:

I. EXCEPT AS EXPRESSLY PROVIDED BY THE LIMITED WARRANTY IN SECTION (A), SELLER MAKES NO OTHER REPRESENTATION OR WARRANTY, WITH RESPECT TO THE SYSTEM, ANY COMPONENT, ANY THIRD PARTY PRODUCT, OR THE APP, INCLUDING BUT NOT LIMITED TO, IMPLIED CONDITIONS OF FITNESS FOR A PARTICULAR PURPOSE, MERCHANTABILITY, NON-INFRINGEMENT, WARRANTIES ARISING FROM COURSE OF DEALING OR USAGE OF TRADE OR ANY OTHER MATTER. SELLER MAKES NO REPRESENTATIONS WHATSOEVER, WHETHER EXPRESS OR IMPLIED, TO ANY PERSON OTHER THAN THE BUYER. NO AGENT, EMPLOYEE OR REPRESENTATIVE OF SELLER HAS ANY AUTHORITY TO BIND SELLER TO ANY AFFIRMATION, REPRESENTATION OR WARRANTY EXCEPT AS STATED IN A WRITTEN DOCUMENT SIGNED BY AN AUTHORIZED OFFICER OF SELLER. ALL WARNINGS CONTAINED IN THE LABELING FOR THE SYSTEM ARE AN INTEGRAL PART OF THIS LIMITED WARRANTY.

II. SELLER IS NOT RESPONSIBLE FOR ANY INCIDENTAL, CONSEQUENTIAL DAMAGES BASED ON ANY DEFECT, FAILURE OR MALFUNCTION OF THE SYSTEM, ANY COMPONENT, ANY THIRD PARTY PRODUCT, OR THE APP, WHETHER THE CLAIM IS BASED ON WARRANTY, CONTRACT, TORT OR OTHERWISE. SELLER SHALL HAVE NO LIABILITY TO ANY PERSON FOR, AND BUYER HEREBY EXPRESSLY WAIVES, ALL REMEDIES AND DAMAGES RELATING TO INDIRECT, INCIDENTAL, CONSEQUENTIAL, SPECIAL OR PUNITIVE DAMAGES OF ANY DESCRIPTION, WHETHER ARISING OUT OF WARRANTY OR OTHER CONTRACT, NEGLIGENCE OR OTHER TORT, OR OTHERWISE, INCLUDING, WITHOUT LIMITATION, RESCISSION, DIFFERENCE IN VALUE DAMAGES, FORESEEABLE BUSINESS LOSSES, LOSS OF PROFITS AND RELIANCE DAMAGES. UNDER NO CIRCUMSTANCES SHALL SELLER'S LIABILITY HEREUNDER FOR ANY CAUSE EXCEED THE PURCHASE PRICE PAID BY BUYER FOR THE COMPONENT OR THIRD PARTY PRODUCT OUT OF WHICH SUCH CLAIM OR ACTION AROSE. THE PARTIES EXPRESSLY AGREE THAT THE EXCLUSIONS AND LIMITATIONS SET FORTH HEREIN ARE AGREED ALLOCATIONS OF RISK AND SHALL SURVIVE THE DETERMINATION OF ANY COURT OF COMPETENT JURISDICTION THAT ANY REMEDY PROVIDED HEREIN FAILS OF ITS ESSENTIAL PURPOSE.

III. THE EXCLUSIONS, DISCLAIMERS, AND LIMITATIONS SET FORTH HEREIN ARE NOT INTENDED TO, AND SHALL NOT BE CONSTRUED AS TO, CONTRAVENE MANDATORY PROVISIONS OF ANY APPLICABLE LAW OR REGULATION. IF ANY PART OF THIS SECTION IS HELD TO BE ILLEGAL OR UNENFORCEABLE BY A COURT OF COMPETENT JURISDICTION, THE PART SHALL BE MODIFIED SO AS TO BE ENFORCEABLE TO THE MAXIMUM EXTENT POSSIBLE. IF THE PART CANNOT BE MODIFIED, THEN THAT PART MAY BE SEVERED AND THE OTHER PARTS OF THE LIMITED WARRANTY SHALL REMAIN IN FULL FORCE AND EFFECT. THIS LIMITED WARRANTY IS EXPRESSED FOR THE SOLE BENEFIT OF THE ORIGINAL USER WHO PURCHASES OR RECEIVES THE SYSTEM, COMPONENT, APP, OR THIRD PARTY PRODUCT, AND IS NOT TRANSFERABLE.

1.15 Appendix I: remedē® System IPG Specifications

1.15.1 Physical Characteristics

Table 12 remedē System IPG Physical Description

Description	IPG Model		
	1600	1100	1001
Height	64.5 mm	71 mm	80 mm
Length	62.5 mm	62.5 mm	47.5 mm
Can Thickness	11 mm	11 mm	11.5 mm
Header Thickness	11 mm	14 mm	14.6 mm
Volume	29 cm ³	33 cm ³	39 cm ³
Mass	43 g	47 g	64 g
Materials exposed to tissue	Titanium, epoxy resin, silicone rubber	Titanium, epoxy resin, silicone rubber	Titanium, epoxy resin, silicone rubber

1.15.2 Lead Connectors

The remedē Pulse Generators have been designed to accept the following leads:

- Model 1001 and Model 1100: 3.2 mm IS-1 lead terminal pins
- Model 1600: In-line Terminal pins

1.15.3 Radiopaque Identification

A radiopaque ID marker, placed inside the remedē IPG connector block in the Model 1001 IPG and inside the titanium can (above the battery) in the Model 1100/1600 IPGs, allows the model number and year of manufacture to be identified by normal X-ray techniques. The identification is composed by the manufacturer's identification code (CCI), the model code (E for the Model 1001 IPG, EL for the Model 1100/1600 IPG) and the last two digits of the manufacture year (Figure 32).



Figure 32 remedē System IPG Radiopaque Identifier

1.15.4 Battery Information

Table 13 remedē System IPG Battery Information

	Model 1001 IPG	Model 1100/1600 IPG
Chemistry	Lithium Carbon Monofluoride (CFx)	
Part Number	WG 9086	M3946
Nominal Voltage	2.9 – 2.95 Volts (at 37°C)	
Capacity	2.2 Amp-hours (Ah)	2.9 Amp-hours (Ah)
Elective Replacement Indicator (ERI)	2.60 Volts	
End of Life (EOL)	2.50 Volts	

Table 14 remedē System IPG – Battery Longevity Estimates

Settings Description	Low Energy Use Settings	Normal Energy Use Settings	High Energy Use Settings
Stimulation Amplitude	2 milliamperes (mA)	5 mA	10 mA
Therapy Dose	6 hours	6.5 hours	7 hours
Stimulation Pulse Width	60 micro seconds (μs)	150 μs	300 μs
Stimulation Frequency	20 hertz (Hz)	20 hertz (Hz)	40 hertz (Hz)
Stimulation Lead Impedance	1500 ohms (Ω)	1000 ohms (Ω)	500 ohms (Ω)
Stimulation Mode	Asynchronous	Asynchronous	Asynchronous
Stimulation Duty Cycle	50 %	50 %	50 %
System Measurements	Transthoracic Impedance, Posture	Transthoracic Impedance, Posture	Transthoracic Impedance, Posture
Model 1100/1600 Battery Longevity Estimate*	73 months	60 months	21 months
Model 1001 Battery Longevity Estimate*	55 months	41 months	17 months

*Due to the anatomical relationship between the phrenic nerve and lead electrodes, patients implanted with the respistim® L (left) stimulation lead typically have normal to high longevity estimates. Patients implanted with the respistim® R (right) stimulation lead typically have normal to low longevity estimates.

1.15.5 Programmable Settings

Table 15 remede® System IPG Programmable Settings

Parameter	Factory Value	Programmable Values	Increment
Therapy			
Mode	Off	Off, Therapy, Monitor	
Algorithm Mode	Asynchronous	Asynchronous, Synchronous	
Asynchronous Respiratory Rate	16 breaths per minute (bpm)	10 – 30 bpm	1 bpm
Stay in Monitor	Yes	Yes, No	
Asynchronous I:E Ratio	1.0	0.5 – 2.0	0.1
Synchronous Backup Ventilation	16 bpm	10 – 30 bpm	1 bpm
Synchronous Backup Only	Off	On, Off	
Synchronous Stimulation Duration	2.0 seconds (sec)	0.5 – 30.0	0.1 sec
Synchronous Delay	0.5 sec	0.1 – 4.0 sec	0.1 sec
Synchronous Blanking Period	0.4 sec	0.1 – 20.0 sec	0.1 sec
Scheduled Sleep Start (all days)	22:00 (HH:MM)	00:00 – 23:30 (HH:MM)	30 min
Scheduled Sleep Stop (all days)	06:00 (HH:MM)	00:00 – 23:30 (HH:MM)	30 min
Maximum Dose	8 hours (hrs)	00:30 – 12:00	30 min
Lack of Respiration Period	8.0 sec	0.5 – 30.0 sec	0.5 sec
Stimulation			
Amplitudes (Supine, Left, Right, Prone)	0.1 mA	0.0 – 10.0 mA	0.1 mA
Maximum Amplitudes (Supine, Left, Right, Prone)	0.1 mA	0.1 – 10.0 mA	0.1 mA
Pulse Width	150 µs	60 – 300 µs	30 µs
Frequency	20 Hz	10, 20 40 Hz	
Cathode (-)	Electrode 1	Electrode 1, 2, 3, 4, 5, 6	
Anode (+) *Electrode 5 not selectable as an Anode in Model 1001 IPG	Electrode 2	Electrode 1, 2, 3, 4, 5*, 6, Can	
Suspension Window	1.0 min	0.0 – 5.0 min	0.5 min

Table 15 **remedē® System IPG Programmable Settings**

Parameter	Factory Value	Programmable Values	Increment
Stimulation Duration Adaption	No	Yes, No	
Current Amplitude Adaption	Off	On, Off	
Continue at I _{max}	On	On, Off	
Ramps			
Rising Duration	30 %	0 – 100 %	10%
Falling Duration	10 %	0 – 100 %	10%
Baseline Amplitude	50 %	0 – 90 %	10%
Titration			
Nightly Titration (all intervals)	100 %	50 – 100 %	5 %
Nightly Titration Time	Absolute	Absolute, Relative	
Weekly Titration	Off	On, Off	
Week 2 ... Week 8	0.0 mA	0.0 – 0.5 mA	0.1 mA
Sensors			
Activity Threshold	8	0 – 16	1
Activity Window	2.0 min	0.5 – 5.0 min	0.5 min
Sleep Latency	5 min	2 – 15 min	1 min
BioBreak Threshold	2 min	1 – 15 min	1 min
Pitch Threshold	50 degrees (deg)	5 – 90 deg	5 deg
Left – Supine Threshold	40 deg	0 – 170 deg	10 deg
Left – Prone Threshold	160 deg	10 – 180 deg	10 deg
Right – Supine Threshold	-40 deg	0 – -170 deg	10 deg
Right – Prone Threshold	-160 deg	-10 – -180 deg	10 deg
Transthoracic Impedance Measure			
Enable	On	On, Off	
Configuration (Model 1001/1100 IPGs)	Sensing – Can	Sensing – Stim, Sensing – Can, Stim – Can	
Configuration (Model 1600 IPG)	Stim – Can	Stim – Can	

1.16 Appendix II: respistim® L, LQ, and LQS Stimulation Lead Specifications

1.16.1 Physical Characteristics

Recommended Guiding Catheter 7 French minimum

Electrodes

- Material Platinum/Iridium
- Electrode Surface Area 12 millimeters²
- Coating None
- Steroid None

Lead Diameter

- Proximal Body 3.6 French (L, LQS Model 40XX; LQ Model 50XX)
4.8 French (LQS Model 41XX, 46XX; LQ Model 51XX)
- Distal Body 3.9 French
- Inside Diameter 0.020 inch
- Insulation Material Polyurethane 90A

Terminal

- Compatibility IS-1: Model 200X, 40XX, 41XX, 50XX, 51XX
In-line: Model 46XX, Model 56XX
- Material 316L Stainless Steel

Conductors

- Type Co-radial design, hexafilar coil with coated wire

Table 16 respistim L, LQ, and LQS Lead Model Descriptions (IS-1 Terminal Models)

respistim L	
Model	Length (centimeters)
2001	35
2002	45
2003	55
2004	70
respistim LQ	
Model	Length (centimeters)
5045 / 5145	45
5055 / 5155	55
5065 / 5165	65
5085 / 5185	85
respistim LQS	
Model	Length (centimeters)
4045 / 4145	45
4055 / 4155	55
4065 / 4165	65
4085 / 4185	85

Table 17 respistim LQ and LQS Lead Model Descriptions (In-line Terminal Models)

respistim LQ		
Model		Length (centimeters)
5645		45
5655		55
5665		65
5685		85

respistim LQS		
Model		Length (centimeters)
4645		45
4655		55
4665		65
4685		85

1.17 Appendix III: respistim® R Lead Specifications

1.17.1 Physical Characteristics

Recommended Introducer 8 French

Electrodes

- Material Platinum/Iridium
- Electrode Surface Area 29 millimeters²
- Coating None
- Steroid None

Lead Diameter

- Proximal Body 4.8 French
- Distal Body 7.0 French
- Inside Diameter 0.020 inch
- Insulation Material Polyurethane 90A

Terminal

- Compatibility IS-1: Model 31XX, 32XX
In-line: Model 36XX
- Material 316L Stainless Steel

Conductors

- Type Co-radial design, hexafilar coil with coated wire

Table 18 respistim R Model Descriptions (IS-1 Terminal Models)

Model	Length (centimeters)	Distal Helical Spring Length (millimeters)	Distal Helical Spring Diameter (millimeters)
3101	60	25	20
3102	60	25	24
3103	60	35	20
3104	60	35	24
3105	60	45	20
3106	60	45	24
3201	80	25	20
3202	80	25	24
3203	80	35	20
3204	80	35	24
3205	80	45	20
3206	80	45	24

Table 19 respistim R Model Descriptions (In-line Terminal Models)

Model	Length (centimeters)	Distal Helical Spring Length (millimeters)	Distal Helical Spring Diameter (millimeters)
3651	50	25	20
3652	50	25	24
3653	50	35	20
3654	50	35	24
3655	50	45	20
3656	50	45	24
3601	60	25	20
3602	60	25	24
3603	60	35	20
3604	60	35	24
3605	60	45	20
3606	60	45	24
3611	80	25	20
3612	80	25	24
3613	80	35	20
3614	80	35	24
3615	80	45	20
3616	80	45	24

1.18 Appendix IV: Additional Programmer and eIPG Details

The programmer display is a commercially available tablet computer certified for use in a clinical environment as the **remedē**[®] System Programmer. The programmer does not contain any user serviceable parts.

1.18.1 Power Supply

The **remedē** System Programmer is provided with a medical grade power supply and power cable that fulfills the standard IEC 60601-1:2012. The power supply is rated as follows: 100-240 VAC, 2.0-1.0A, 50-60Hz.

Use only the power supply and power cable provided by Respicardia. The power supply provides electrical isolation to the patient and operator from electrical power mains.

1.18.2 Routine Cleaning

Always turn the **remedē** System programmer OFF prior to cleaning.

When necessary, it is recommended that a soft cloth dampened with distilled water or isopropyl alcohol be used to wipe the exterior case of the programming wand. Do not use solvents or cleaning cloths containing chemical cleaning agents.

1.18.3 Cybersecurity Considerations

Do not attempt to install software on the **remedē** System Programmer. Software installation may introduce viruses/ malware into the system and corrupt the system configuration. This may result in a malfunction or the inability to use the **remedē** System Programmer.

The **remedē** System Programmer wireless network (Wi-Fi) access has been disabled to enhance system cybersecurity robustness. Do not remove the **remedē** System Programmer Micro SD port cover at any time.

Do not attempt to use Wi-Fi via a USB connection on the **remedē** System Programmer. The **remedē** System Programmer is not intended for use with any Wi-Fi connection.

1.18.4 eIPG Cable

The **remedē** eIPG is used with a sterile cable having two covered alligator clips on one end and two 2mm male shrouded connector pins on the opposite end. The cable should have a length of 2-3 meters.

1.19 Appendix V: remedē® System Programmer Electromagnetic Interference Information

The **remedē** System may be subject to interference caused by other electrical equipment being operated in the near vicinity. Specifically, portable and mobile radiofrequency (RF) equipment can interfere with the normal operation of the programming system. This shall be taken into account in any situation where the equipment is not operating as expected. The **remedē** System Programmer may be interfered by other equipment, even if that equipment complies with CISPR emission limits. Use of accessories, transducers and cables other than those specified or provided by the manufacturer of this equipment could result in increased electromagnetic emissions or decreased electromagnetic immunity of this equipment and result in improper operation.

Table 20 Electromagnetic Emissions Guidance Declaration

Guidance and manufacturer's declaration – Electromagnetic Emissions		
The remedē System Programmer is intended for use in the electromagnetic environment specified below.		
Emissions Test	Compliance	Electromagnetic Environment – Guidance
RF emissions CISPR 11	Group 1	The remedē System programmer uses RF energy only for its internal function. Therefore, its RF emissions are very low and are not likely to cause interference in nearby electronic equipment.
RF emissions CISPR 11	Class B	The remedē System is suitable for use in all establishments, including domestic establishments and those directly connected to the public low voltage power supply network that supplies buildings used for domestic purposes.
Harmonic Emissions IEC 61000-3-2	Class A	
Voltage fluctuations/flicker emissions IEC 61000-3-3	Complies	

Table 21 Electromagnetic Immunity Guidance Declaration

Guidance and Manufacturer’s Declaration – Electromagnetic Immunity			
The remedē ® System programmer is intended for use in the electromagnetic environment specified below. The remedē System should not be used adjacent to or stacked with other equipment and that if adjacent or stacked use is necessary, the remedē System should be observed to verify normal operation in the configuration in which it will be used.			
Immunity Test	IEC 60601 Test Level	Compliance Level	Electromagnetic Environment – Guidance
Electrostatic discharge (ESD) IEC 61000-4-2	±8 Kilovolt contact ±15 Kilovolt air	±8 Kilovolt contact ±15 Kilovolt air	The relative humidity should be at least 5%. Refer to the ESD guidance in paragraph 1.20.2.1.
Electrical fast transient/burst IEC 61000-4-4	±2 Kilovolt for power supply lines ±1 Kilovolt for input/output lines	±2.0 Kilovolt for power supply lines ±1 Kilovolt for input/output lines	Mains power should be that of a typical hospital environment. Do not operate motors or other electrically noisy equipment on the same mains circuit as the remedē System Programmer.
Surge IEC 61000-4-5	±1 Kilovolt, differential mode ±2 Kilovolt, common mode	±1 Kilovolt, differential mode ±2 Kilovolt, common mode	Mains power quality should be that of a typical commercial or hospital environment.
Voltage dips, short interruptions and voltage variations on power supply input lines IEC 61000-4-11	U_T 0% U_T for 0.5 cycle at 0°, 45°, 90°, 135°, 180°, 225°, 270° and 315°; 0% U_T for 1 cycle; 70% U_T for 25 cycles; 0% U_T for 250 cycles	100% dip in U_T for 0.5 cycle at 0°, 45°, 90°, 135°, 180°, 225°, 270° and 315°; 100% dip in U_T for 1 cycle; 30% dip in U_T for 25 cycles; 100% dip in U_T for 250 cycles	Mains power quality should be that of a typical commercial or hospital environment. Note: If the user of the remedē System Programmer requires continued operation during power interruptions, it is recommended that the remedē System Programmer be powered from an uninterruptible power supply or battery.
Power frequency (50/60 Hz) IEC 61000-4-8	30 A/m	30 A/m	Power frequency magnetic fields should be at levels characteristic of a typical location in a typical commercial or hospital environment.
NOTE: U_T is the AC mains voltage prior the application of the test level.			

Table 22 Electromagnetic Immunity Guidance Declaration

Guidance and Manufacturer’s Declaration – Electromagnetic Immunity			
The remedē System programmer is intended for use in the electromagnetic environment specified below.			
Immunity Test	IEC 60601 Test Level	Compliance Level	Electromagnetic Environment – Guidance
Conducted RF IEC 61000-4-6	3 voltage root mean square (Vrms) 150 kilo hertz (KHz) to 80 mega hertz (MHz)	3 V	Except as indicated in Table 24 , portable and mobile RF communications equipment should be used no closer to any part of the remedē System Programmer including cables, than the recommended separation distance calculated from the equation applicable to the frequency of the transmitter. Recommended separation distance: $d = 1.2 \sqrt{P}$ 150 kHz to 80 MHz ^c $d = 1.2 \sqrt{P}$ 80 MHz to 800 MHz ^d $d = 2.3 \sqrt{P}$ 800 MHz to 2.7 GHz ^d where <i>P</i> is the maximum output power rating of the transmitter in watts (W) according to the transmitter manufacturer and <i>d</i> is the recommended separation distance in meters (m). Field strengths from fixed RF transmitters, as determined by an electromagnetic site survey, ^a should be less than the compliance level in each frequency range. ^b Interference may occur in the vicinity of equipment marked with the following symbol: 
	6 voltage root mean square (Vrms) ISM Bands	6 V	
Radiated RF IEC 61000-4-3	3 V/m 80 MHz to 2.7 giga hertz (GHz)	3V/m	
NOTE 1 At 80 MHz and 800 MHz, the higher frequency range applies.			
NOTE 2 These guidelines may not apply in all situations. Electromagnetic propagation is affected by absorption and reflection from structures, objects and people.			
^a Field strengths from fixed transmitters, such as base stations for radio (cellular/cordless) telephones and land mobile radios, amateur radio, AM and FM radio broadcast and TV broadcast cannot be predicted theoretically with accuracy. To assess the electromagnetic environment due to fixed RF transmitters, an electromagnetic site survey should be considered. If the measured field strength in the location in which the remedē System Programmer is used exceeds the applicable RF compliance level above, the remedē System Programmer should be observed to verify normal operation. If abnormal performance is observed, additional measures may be necessary, such as relocating the remedē System Programmer.			
^b Over the frequency range 150 kHz to 80 MHz, field strengths should be less than 3V/m.			
^c For Conducted RF			
^d For Radiated RF			

Table 23 Recommended Separation Distances Between Portable and Mobile RF Communications Equipment

Recommended separation distances between portable and mobile RF communications equipment and the remedē ® System programmer			
<p>The remedē System programmer is intended for use in an electromagnetic environment in which radiated RF disturbances are controlled. The customer or user of the remedē System programmer can help prevent electromagnetic interference by maintaining a minimum distance between portable and mobile RF communications equipment (transmitters) and the remedē System programmer as recommended below, according to the maximum output power of the communications equipment except as indicated in Table 24.</p> <p>Warning: <i>Portable RF communications equipment (including peripherals such as antenna cables and external antennas) should be used no closer than 30 cm (12 inches) to any part of the external remedē System components.</i></p>			
Rated maximum output power of transmitter W	Separation distance according to frequency of transmitter M		
	150 kHz to 80 MHz $d = 1.2 \sqrt{P}$	80 MHz to 800 MHz $d = 1.2 \sqrt{P}$	800 MHz to 2.7 GHz $d = 2.3 \sqrt{P}$
0.01	0.1	0.4	1.5
0.1	0.4	0.7	2.0
1	1.2	1.3	2.6
10	3.7	2.3	3.5
100	12	4.0	4.7
<p>For transmitters rated at a maximum output power not listed above, the recommended separation distance d in meters (m) can be estimated by using the equation applicable to the frequency of the transmitter, where P is the maximum output power rating of the transmitter in watts (W) according to the transmitter manufacturer.</p> <p>NOTE 1 At 80 MHz and 800 MHz, the higher frequency range applies.</p> <p>NOTE 2 These guidelines may not apply in all situations. Electromagnetic propagation is affected by absorption and reflection from structures, objects and people.</p>			

Table 24 **Frequencies of Portable and Mobile Transmitters for which the Recommended Separation Distance is 30 cm (12 inches)**

Recommended separation distances of 30cm (12 inches) between portable and mobile transmitters and the remedē ® System programmer for transmitter frequency bands		
Band (MHz)	Service	Immunity Test Level (V/m)
380 - 390	TETRA 400	27
430 - 470	GMRS 460, FRS 460	28
704 - 787	LTE Band 13, 17	9
800 - 960	GSM 800/900, TETRA 800, iDEN 820, CDMA 850, LTE Band 5	28
1,700 – 1,990	GSM 1800; CDMA 1900; GSM 1900; DECT; LTE Band 1, 3, 4, 25; UMTS	28
2,400 – 2,570	Bluetooth, WLAN, 802.11 b/g/n, RFID 2450, LTE Band 7	28
5,100 – 5,800	WLAN 802.11 a/n	9

1.20 Appendix VI: **remedē**[®] System Programmer Communications & Telemetry

1.20.1 Telemetry Data

Telemetry communication through magnetic induction with the programmer provides the means to view and set system parameters and collect device data obtaining the following information:

- All programmable parameters
- Patient information (IPG model/serial number, Lead model/serial number, Patient ID, Physician contact information, implant date, patient time zone)
- Battery voltage and condition indicator (Good, Early Replacement Indicator [ERI], and End of Life [EOL])
- Statistics that include sensing and stimulation events
- Stimulation lead impedance as well as historical record of these values

The **remedē** System programmer communicates with the **remedē** IPG using a proprietary telemetry communication protocol.

Table 25 Telemetry Transmission Characteristics

remedē System Programmer Transmission Characteristics to Implanted Device
ASK: “0” = tone absence, “1” = tone presence, Bit length = 0.305 ms 16-20 kHz carrier Range: ≤ 6 cm Power: 0.56W _{peak} , 0.27W _{average}

1.20.2 Troubleshooting

Telemetry communication through magnetic induction with the programmer may encounter situations that require user intervention. The following are potential communication issues that may occur and the action that should be taken by the user.

1.20.2.1 Loss of Communication with Programmer Wand

If a loss of communication between the Programmer Display and the Programmer Wand has occurred, a message indicating loss of interface connection will appear on the Programmer Display.

Action: Unplug the USB cable connecting the Programmer Wand to the Programmer Display and wait at least 5 seconds before reconnection.

- **Additional Information:** A loss of communication may be incurred by unplugging the USB cable or as a safety effect in the presence of excessive electromagnetic disturbance, an excessive electrostatic discharge (ESD), or other high energy burst (e.g. external defibrillation).

1.20.2.2 Loss of Marker Mode or Other Telemetry Error Messages

If a loss of communication between the Programmer Wand and the implanted device has occurred, a message indicating loss of telemetry connection will appear on the Programmer Display.

Action: Confirm the Programming Wand is within the secure communication zone and attempt telemetry operation again.

- **Additional Information:** A loss of communication may incur due to the Programming Wand not being within the secure communication zone or a result of the presence of excessive electromagnetic disturbance, excessive electrostatic discharge (ESD), power surges, or other high energy burst (e.g. external defibrillation).

1.20.2.3 Loss of Programmer Operating System Functions

If the Programmer Display experiences a functional error as related to the PC's Operating System the Windows system may report an error or cause the screen to become blue with reported error condition, or become non-responsive to any attempted input.

Action: The Programmer Display may be reset by pushing the recessed button on the backside of the PC tablet. If the tablet does not have a recessed button, press and hold the On/Off button on the side of the tablet for 10 seconds. Once the system returns to the Windows desktop, launch the **remedē**[®] System Programmer Software Application and proceed with the programming session.

- **Additional Information:** A system error, while rare, may occur with the Windows Operating System of the **remedē** System Programmer Display due to any number of reasons. If the error is repeated the user should contact the **remedē** team.
- **Note:** If any unforeseen problem arises that renders the programmer unable to perform normally, the user should contact the **remedē** team.

1.21 Appendix VII: Service and Disposal Information

1.21.1 Service

All servicing of the **remedē**[®] System Programmer components shall be performed by ZOLL Respicardia, Inc. personnel. For Customer service, contact the address below:

ZOLL Respicardia, Inc.

12400 Whitewater Drive, Suite 150

Minnetonka, MN 55343 USA

Phone: (952) 540-4470

Fax: (952) 540-4485

E-mail: info@remede.zoll.com

remede.zoll.com

1.21.2 Disposal

The **remedē** IPG and leads that have been exposed to blood and/or body fluids shall be considered to be a potential biohazard and disposed of according to local environmental regulations. The **remedē** System programmer, programming wand, and external IPG shall be considered as electronic waste and disposed of according to local environmental regulations.

ZOLL Respicardia, Inc.

12400 Whitewater Drive, Suite 150

Minnetonka, MN 55343 USA

Phone: (952) 540-4470

Fax: (952) 540-4485

E-mail: info@remede.zoll.com

remede.zoll.com

Patents: remede.zoll.com/patents

The information in this document can be changed without previous warning. No part of this manual may be reproduced or transmitted in any way or by any means, either electronic or mechanical, for any purpose without explicit written allowance by Respicardia, Inc.

ER1300, Revision H